

# Mariak

Many Window Solutions From One Source

## Cellular Shade Section

Effective December 9, 2013



Save a life: "Install Safety Tension Device!"

## Measuring & Ordering Instructions

### Selecting the Type of Mounting:

Determine whether the cellular shade is going to be installed inside the window frame or outside the window frame.

### Inside Mount (IB):

Inside mount installations are often preferred because the shades take up less space in the room.

#### Measuring the Width and the Length for Inside Mount:

For the width, measure across the top, middle, and bottom of the window opening. Using the narrowest dimension, measure to the nearest 1/8". By using the narrowest measurement the shade will operate correctly.

For the length, measure the up and down dimension on the left, center, and right side. Use the longest length measurement, measuring to the nearest 1/8".

The factory will make any appropriate deductions. Do not make any width deductions.

### Outside Mount (OB):

Outside mount installations are mounted on the wall or on the window molding. It is best to overlap the window opening at least 3/4" on each side when measuring for cellular shades.

#### Measuring the Width and the Length for Outside Mount:

Measure the area that the cellular shade is to cover. For cellular shades it is recommended to overlap the window opening by at least 3/4" on each side for a total of 1 1/2". To allow for enough space for the mounting brackets and to cover the bottom of the window, the suggested overlap for a cellular shade is at least 3" (1 1/2" above the window opening and 1 1/2" below the opening). If the window opening has a sill, measure from where the top of the cellular shade will be located to the top of the window sill.

*Note: When outside mount cellular shades are specified, no factory deductions are taken.*

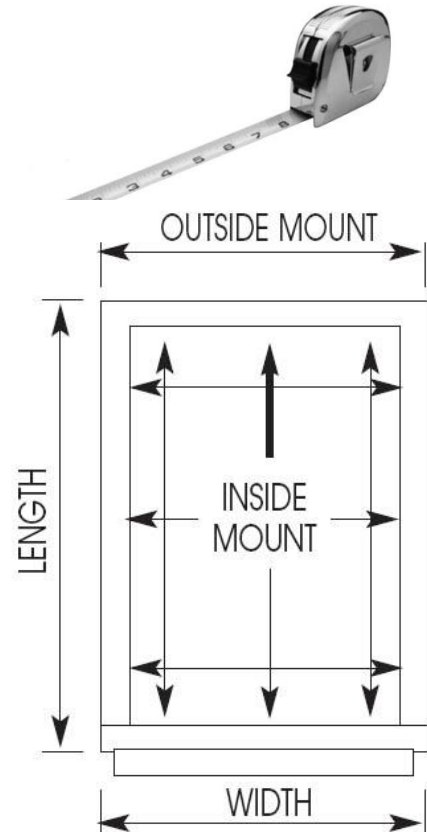

### Confirming Measurements:

The most common error in ordering cellular shades is reversing the width and the length measurements. Always confirm that the width is the measurement that goes across from left to right and that the length is the measurement that goes from top to bottom.

In compliance with the latest manufacturing safety guidelines Mariak Window Fashions includes with each fully-assembled product warning tags, warning labels, safety devices and cord cleats. Installers of the finished product must adhere to the safety guidelines as established by the installation instructions and by using all devices provided by the manufacturer. It is the responsibility of the installer, as well as the end consumer, to see that all safety devices are properly installed according to the manufacturers installation instructions included with each device and remain so throughout the life of the product. Mariak Window Fashions is not liable for injuries or fatal occurrences related to improper installation or maintenance of required safety devices.

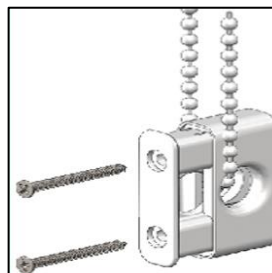

**All prices are in U.S. Dollars and do not include freight, duties or taxes for shipment to Alaska, Hawaii or Canada. GST and VAT are not included. Other restrictions and surcharges may apply. See Freight Policy for complete details.**

**Manufacturing specifications, options, surcharges and pricing are subject to change without notice.**

Visit [www.mariak.com](http://www.mariak.com) for the most recent downloads.

# Mariak

Many Window Solutions From One Source

## Pull Cord (Cord Lock) Cellular Shade Exploded Diagram

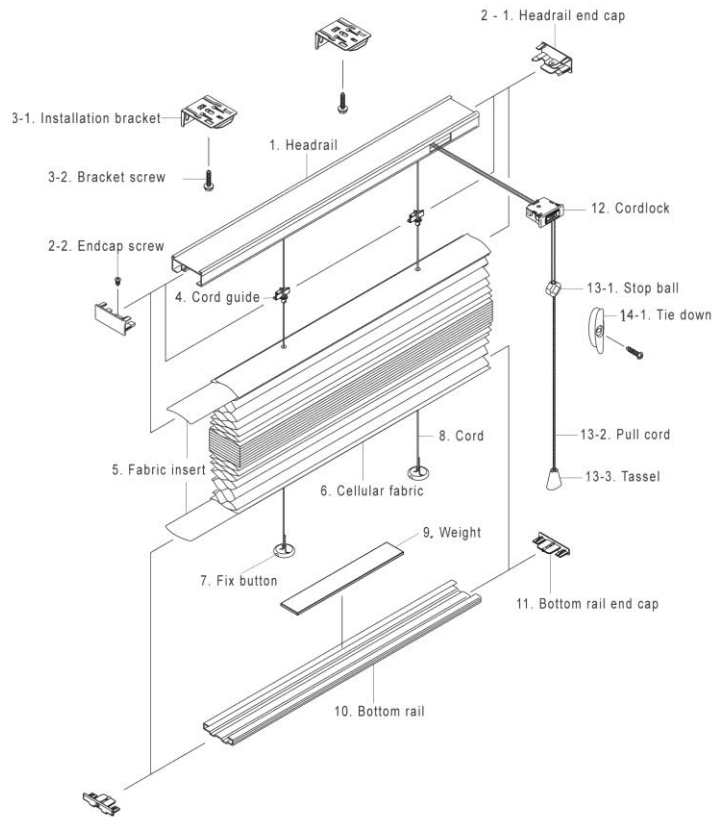

Standard Brackets:

- 3/4" High
- 1-5/8" Deep
- 1-3/8" Wide

## Cord Loop Clutch Cellular Shade Exploded Diagram

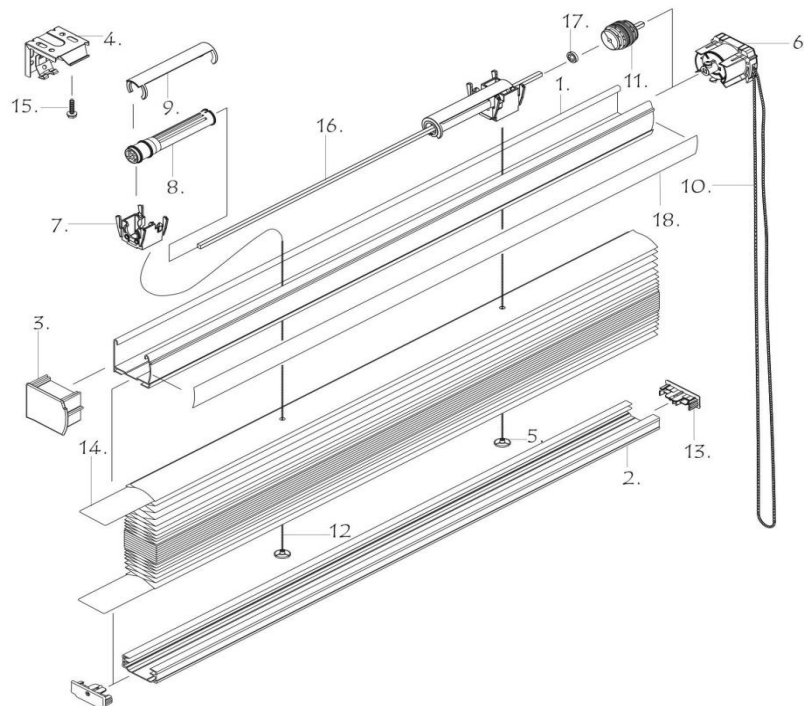

1. Cord Loop Headrail
2. Bottom Rail
3. Cord Loop Headrail End Cap
4. Installation Brackets
5. Fix Button
6. Clutch Mechanism
7. Tape Drum Support
8. Tape Drum
9. Tape Drum Cover
10. Continuous Cord Loop
11. Separator
12. 0.9mm Nylon Cord
13. Bottom Rail End Caps
14. Fabric Stiffener
15. Installation Screws
16. Tilt Rod
17. Tilt Rod Stopper
18. Aluminum Insert Valance

Cordless & Continuous Cord Loop Brackets:

- 1-7/8" High
- 1-3/4" Deep
- 1-5/8" Wide

# Mariak

Many Window Solutions From One Source

## Cordless Cellular Shade Exploded Diagram

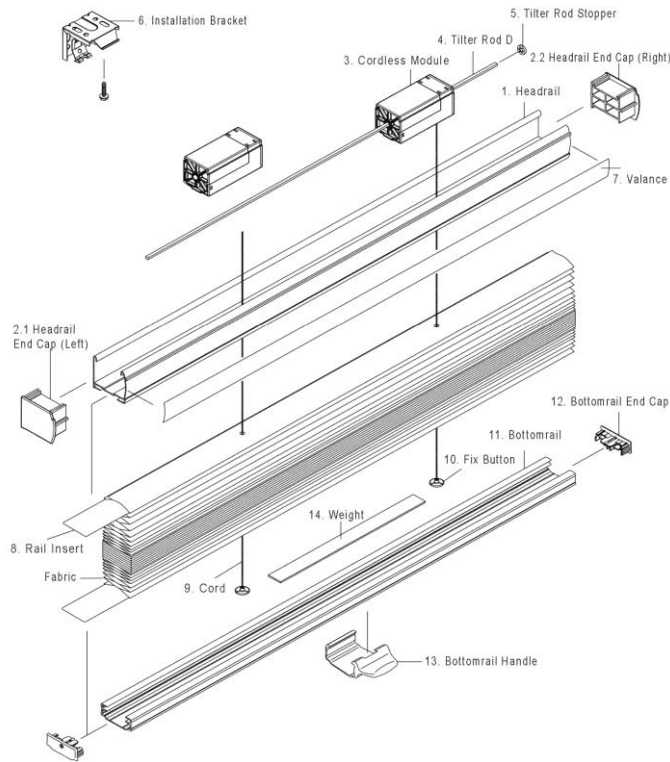

## Top-Down/Bottom-Up Cordless Cellular Shade Exploded Diagram

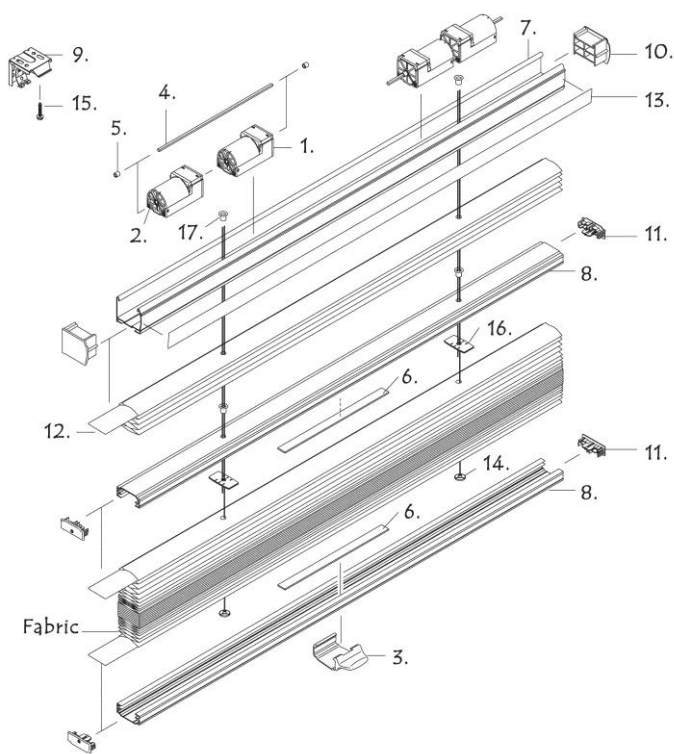

1. Cordless Module
2. Cordless Module Housing
3. Bottom Rail Handle
4. Tilt Rod
5. Tilt Rod Stopper
6. Bottom Rail Weights
7. Cordless Headrail
8. Bottom Rail
9. Installation Brackets
10. Cordless Headrail End Caps
11. Bottom Rail End Caps
12. Fabric Stiffener
13. Aluminum Insert Valance
14. Fix Button
15. Installation Screws
16. Plastic Washer
17. Eyelet

## Cellular Shade Options

### Standard Pull Cord Cellular Shade

This cellular shade is operated by pulling a lift cord. Using a heavy duty cord lock mechanism, the shade can be raised or lowered by simply releasing the pull cord with a slight tug at an angle. This action will stop the shade from being raised or lowered and will lock the shade in place.

Minimum Width: 8"  
 Maximum Width: 96" as 1 piece or 144" as a 2-On-1 Shade  
 Minimum Height: 8"  
 Maximum Height: 144"

### Continuous Cord Loop Cellular Shade

This cellular shade is raised or lowered by pulling a continuous cord. Cord loop shades use a heavy duty clutch operating device that makes lifting the shade a breeze. It also allows the consumer to position the shade exactly at the preferred height. This clutch feature eliminates concerns about the cord lengthening and reaching the floor as the shade is raised because the cord loop always remains the same height. Shades with this upgrade will remain level as the shade is raised and lowered.

Minimum Width: 18"  
 Maximum Width: 120" as 1 piece or 144" as a 2-On-1 Shade  
 Minimum Height: 8"  
 Maximum Height: 144"

### Top-Down Only Continuous Cord Loop Cellular Shade

Using the continuous cord loop mechanism described above, this shade option lowers the fabric from the top of the shade. The bottom rail of the shade is stationary and fixed at the bottom of the window. This option allows light from above without forgoing privacy from below. Available with continuous cord loop controls only.

Minimum Width: 18"  
 Maximum Width: 72"  
 Minimum Height: 8"  
 Maximum Height: 96"

### Top-Down/Bottom-Up Cellular Shade

This cellular shade features the ability to both raise the shade from the bottom and lower it from the top. It combines both the functions of a standard shade and a top-down only shade. Right side lift cords will raise the shade from the bottom, while left side lift cords lower the shade from the top. Available with standard pull cord controls or cordless.

Minimum Width: 18"  
 Maximum Width: 72"  
 Minimum Height: 12"  
 Maximum Height: 72"

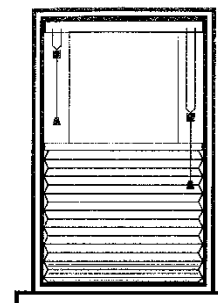
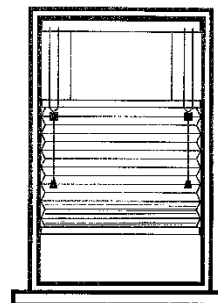
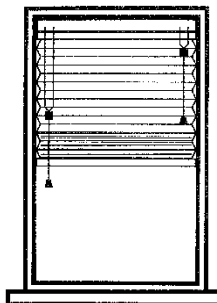
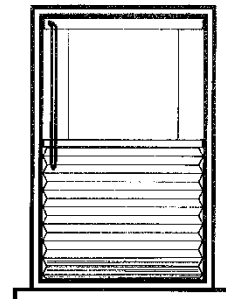
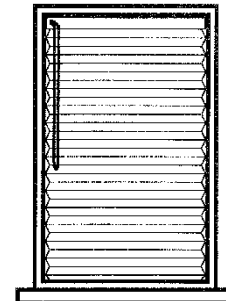
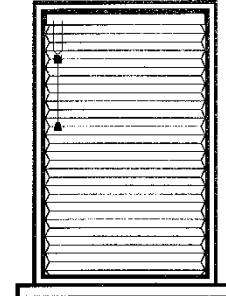

# Mariak

Many Window Solutions From One Source

## Cellular Shade Options

### Cordless Cellular Shade

This cellular shade is operated by pushing up or pulling down the bottom-bar. Using an innovative, state-of-the-art cords-free lifting mechanism, the shade can be raised or lowered by grabbing a handle located at the bottom of the shade. Raising the handle up or pulling the handle down will stop the shade at any mid-window position. Top-Down / Bottom-Up Cordless is available for an additional surcharge.

Standard Cordless		TDBU Cordless	
Minimum Width:	18"	Minimum Width:	18"
Maximum Width:	84"	Maximum Width:	72"
Minimum Height:	12"	Minimum Height:	12"
Maximum Height:	84"	Maximum Height:	72"

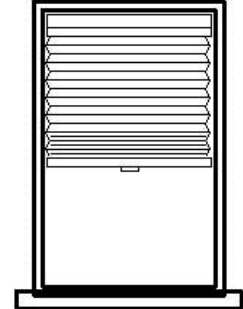

### Day/Night Cellular Shade

This cellular shade option combines two different fabrics in one shade. A room darkening fabric can be lowered from the top of the shade, while a light filtering fabric used for additional privacy can be raised from the bottom. Right side lift cords will control the day/night feature, while left side lift cords raise the entire shade. Available with standard pull cord controls only. Available with 3/4" Single Cell fabrics only.

Minimum Width:	12"
Maximum Width:	72"
Minimum Height:	18"
Maximum Height:	96"

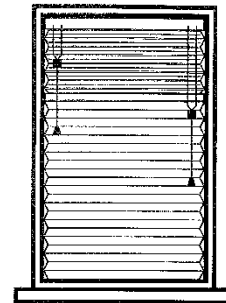
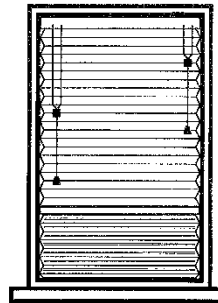

### 2-On-1 Headrail Cellular Shade

#### Pull Cord Shade Option

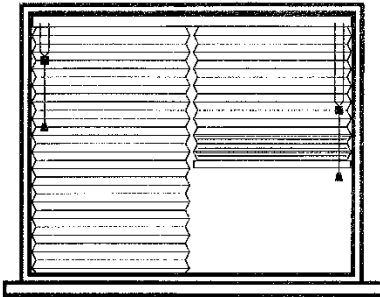

#### Continuous Cord Loop Option

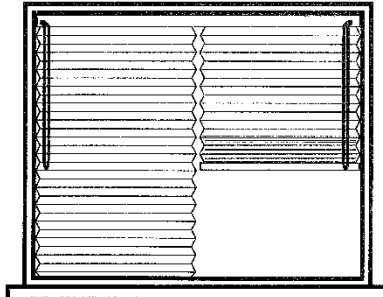

Minimum Width:	8"
Maximum Width:	144"
Minimum Height:	8"
Maximum Height:	144"

Minimum Width:	18"
Maximum Width:	144"
Minimum Height:	18"
Maximum Height:	144"

Note: There will be a 1/8" light gap between the fabric shade panels.

Note: Controls for the left shade will be left and controls for the right shade will be right.

### Fanned Angle Top and Bottom Windows

Minimum Width:	12"
Maximum Straight Width:	72"
Maximum Angle Width:	84"
Minimum Height:	12"
Maximum Height:	96"

Note: This is a non-functioning cord lock.

Note: Angled Top Shades have two top rails.

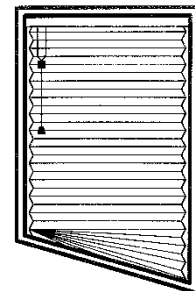
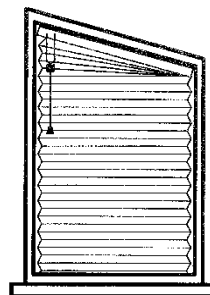

## Cellular Shade Options

### Shade with Cutout

To avoid obstacles, shades may require cutouts. They are available at the bottom of the shade only. Available with both standard pull cord and continuous cord loop controls.

*Note: Please allow 1/4" clearance for the obstacle. The section of the shade below the obstacle will not stack when the shade is raised. There are a maximum of two cutouts per shade.*

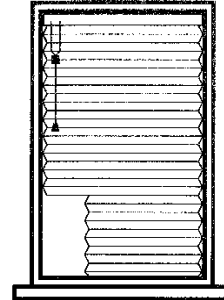

### Additional Specialty Cellular Shade Options

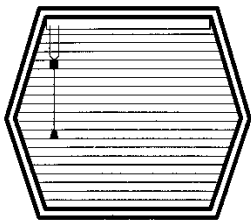

#### Hexagonal Windows

Minimum Width: 12"  
 Maximum Width: 48"  
 Minimum Height: 12"  
 Maximum Height: 48"

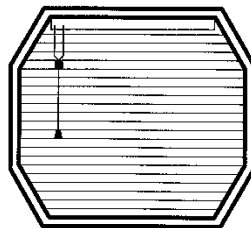

#### Octagonal Windows

Minimum Width: 15"  
 Maximum Width: 48"  
 Minimum Height: 15"  
 Maximum Height: 48"

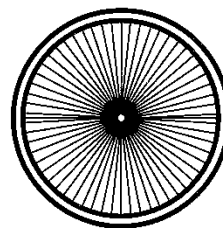

#### Circular Windows

Minimum Diameter: 15"  
 Maximum Diameter: 48"  
 Indicate the width and height at the center of the shade.  
*Note: Stationary shade for inside mount only.*

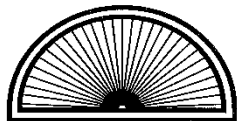

#### Arch Windows

Minimum Width: 12"  
 Maximum Width: 84"  
 Minimum Height: 1/4" of width or 6" (use largest size)  
 Maximum Height: 1/2" of width or 42" (use smallest size)

*Note: Stationary shade.  
 Note: Inside or outside mount.*

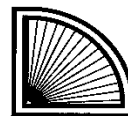

#### Half Arch Windows

Minimum Width: 6"  
 Maximum Width: 42"  
 Minimum Height: 1/4" of width or 6" (use largest size)  
 Maximum Height: 1/2" of width or 42" (use smallest size)

*Note: Stationary shade.  
 Note: Inside or outside mount.*

### Arch Over Window Shades

Minimum Width: 12"  
 Maximum Width: 48"  
 Minimum Height: 18"  
 Maximum Height: 144"

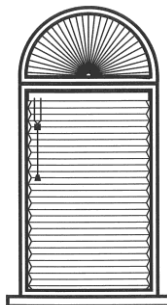

### Special Brackets

#### Hold Down Brackets:

Hold down brackets are available to secure the bottomrail in position. These brackets stop a shade from bouncing and loosely swinging if the shade is hung on a door.

#### Spacer Blocks:

Spacer blocks are available for outside mount shades. When the shade must operate around an obstruction, these spacers project the shade away from the wall to clear the obstruction. Spacer blocks may be stacked for additional projection.

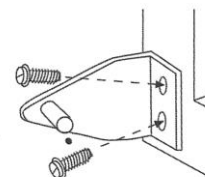

## Cellular Shade Options

### Battery Powered Motorized Cellular Shade

This cellular shade is operated by a battery powered motor system. At the press of a button, shades can be raised up, exposing a room to sunlight, or lowered down, filtering light from entering a room. This unique motor system has full lift control of shades that are up to 12.5 lbs. The motor is powered by AA lithium battery packs, which can be mounted to the ceiling or installed to the wall. The battery life expectancy is 1 to 5 years (based upon 4 operations per day and the weight of the shade). Battery powered cellular shades are available with radio frequency controls. Cellular shades controlled by radio frequency may be operated as an individual unit, as sub-groups, and as an entire group. Please consult Mariak technical support with any questions you may have.

**Battery Powered Cellular Shade Surcharges:** Batteries are included with motors & controls.

- RF Battery Motor – 12-volt..... \$ 750.00
- Radio Frequency Transmitter 1-Ch..... \$ 200.00
- Radio Frequency Transmitter 5-Ch..... \$ 260.00
- Radio Frequency Wall Switch 1-Ch..... \$ 470.00
- Radio Frequency Wall Switch 5-Ch..... \$ 500.00

Minimum Width:	27"	<b>Approximate Size Restriction</b>
Maximum Width:	96"	<b>96" x 96" (Single Cell)</b>
Minimum Height:	18"	<b>84" x 84" (Double Cell)</b>
Maximum Height:	96"	<b>72" x 72" (Blackout Cell)</b>

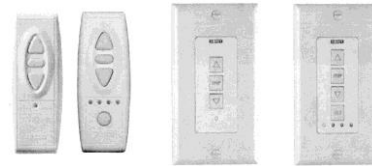

**RF Hand Held Transmitters Available As 1 & 5 Channel**

**RF Wireless Wall Switches Available As 1 & 5 Channel**

## Cellular Shade Fabric Information

**Factory Deductions:** Inside mount shades have a 3/8" deduction in width.

### Headrail Dimensions:

Headrail Type	Cellular Fabric Type	Dimensions
Standard Pull Cord	All Fabrics	1 3/8" X 3/4"
Continuous Cord Loop & Cordless	All Fabrics	1 3/8" X 1 1/2"

### Stack Height Chart: (Includes Headrail and Bottomrail)

Height of Shade	Total Thickness			
	9/16" Single Cell	7/16" Double Cell	3/4" Single Cell	3/4" Blackout
12" – 18"	1 1/4"	2 3/8"	1 3/8"	5"
19" – 30"	2 1/8"	2 3/4"	1 3/4"	5 1/2"
31" – 42"	2 1/4"	3 1/8"	2"	6"
43" – 54"	2 1/2"	3 3/8"	2 1/4"	6 1/4"
55" – 66"	3"	3 3/4"	2 5/8"	6 1/2"
67" – 78"	3 1/2"	4"	2 7/8"	7"
79" – 90"	3 3/4"	4 3/8"	3"	7 3/8"
91 – 96"	4 1/4"	4 3/8"	3 1/8"	7 3/8"

Note: These are estimated measurements and may vary slightly.

### Cleaning Instructions:

Shades should be dusted regularly with a soft, clean cloth, feather duster or lightly vacuumed with a soft brush attachment. To spot clean, use a cloth or sponge with mild detergent and lukewarm water. Rinse thoroughly. Complete immersion is not recommended unless shade is badly soiled. If shade is immersed in water, make certain that all hardware components are thoroughly dried immediately after rinsing. Drain any excess water from fabric and raise shade to set pleats. Lower shade until fabric is completely dry.

### Safety Information:

To insure child safety, it is strongly recommended that each shade be installed with a cord safety cleat provided by the manufacturer.

### Surcharges:

- Cutouts = \$45.00 per cutout
- Top-Down/Bottom-Up = \$60.00 per shade
- Top-Down Only = \$65.00 + Continuous Cord Loop surcharge per shade
- Top-Down/Bottom-Up Cordless = Cordless Surcharge based on price tables + \$60.00
- Day/Night = Price as the total of two separate shades
- Fanned Angled Top or Angled Bottom = \$125.00 per shade

- Battery Powered Motorized Shade = Refer to Page 7
- Cordless Options = See price tables
- Arches, Half Arches, & Specialty Shapes = \$125.00
- Two-On-One Headrail = \$20.00 Net (price as on overall)
- Three-On-One Headrail = \$30.00 Net (price as on overall)





## Cellular Shades

### Suggested Retail Price Table #1

Fabric	Colors	Fabric Width	Privacy Rating	Fabric Type
9/16" Single Cell Point-Bond	5	144"	Light Filtering	Point-Bond
9/16" Single Cell Linen Print	1	144"	Light Filtering	Point-Bond

\*\*\*Note: Shades with Linen Print incur a 15% Surcharge beyond standard 9/16" Single Cell Point-Bond Shade Pricing\*\*\*\*

#### Width

Length	Width														
	24	30	36	42	48	54	60	66	72	84	96	108	120	132	144
36	107	121	138	155	171	187	203	220	236	270	305	354	391	428	464
42	115	131	149	169	187	204	223	241	260	298	336	392	432	473	513
48	123	142	162	182	202	222	242	263	284	326	368	429	474	519	563
54	130	151	173	196	217	240	261	285	307	353	399	467	515	565	614
60	139	161	186	209	233	258	281	307	331	380	431	504	557	611	664
66	147	170	198	223	249	276	300	328	354	408	462	540	599	657	713
72	155	180	209	237	265	293	320	349	378	436	493	578	640	702	763
78	162	191	221	250	281	310	340	371	401	463	524	616	682	748	813
84	168	198	231	262	295	326	357	390	422	487	552	648	719	789	858
90	176	208	242	276	311	343	377	412	446	515	584	685	761	834	908
96	182	217	252	288	324	359	394	431	467	539	612	719	797	875	953
102	191	226	264	301	340	376	414	452	490	567	640	750	829	910	991
108	198	235	275	314	354	392	432	471	511	590	669	783	867	947	1031
114	205	245	287	327	370	410	451	493	535	618	702	822	901	984	1071
120	212	254	297	340	384	426	469	512	555	643	733	860	937	1023	1115
132	226	272	320	366	414	459	506	553	600	699	796	895	975	1064	1160
144	240	290	341	392	443	493	543	594	648	754	860	931	1014	1107	1206
Cord Loop	52	55	57	62	64	66	68	74	78	83	88	95	101	107	110
Cordless	60	70	80	90	105	120	N/A								

Note: Shades measuring more than 96" in width are recommended as a Two-On-One Headrail shade.

Note: Shades measuring more than 72" in width are recommended with a Continuous Cord Loop Control.

Cellular Shade Surcharge Options:	
Linen Print	15%
Cutouts	\$45.00 per cutout
Top-Down/Bottom-Up	\$60.00 (If Cordless, Add \$60.00 to cordless charge)
Top-Down Only	\$65.00 + Continuous Cord Loop surcharge
Day/Night	Price as the total of two separate shades
Two-On-One Headrail	\$20.00 Net (price as one overall shade)
Three-On-One Headrail	\$30.00 Net (price as one overall shade)
Fanned Angled Top or Angled Bottom	\$125.00
Arches & Specialty Shapes	\$125.00
Shades less than 102" in width shipped via FedEx: \$4.00 per unit Net Freight Charge	
Shades 102-1/8" to 125" in width shipped via FedEx: \$75.00 per unit Net Freight Charge	
Shades 125-1/8" or greater in width shipped via Common Carrier: \$ 150.00 per shipment	
All prices are in U.S. Dollars and do not include freight, duties or taxes for shipment to Alaska, Hawaii or Canada. GST and VAT are not included. Other restrictions and surcharges may apply. See freight Policy for complete details.	
Manufacturing specifications, options, surcharges and pricing are subject to change without notice.	

Visit [www.mariak.com](http://www.mariak.com) for the most recent downloads.

## Cellular Shades

**Suggested Retail Price Table #2**

Fabric	Colors	Fabric Width	Privacy Rating	Fabric Type
9/16" Single Cell Spunlace	29	144"	Light Filtering	Spunlace
3/4" Single Cell Spunlace	29	144"	Light Filtering	Spunlace

**Width**

Length	Width														
	24	30	36	42	48	54	60	66	72	84	96	108	120	132	144
36	120	136	155	173	191	208	224	242	258	296	334	389	428	466	502
42	128	146	166	189	208	229	247	268	288	329	372	433	477	520	562
48	137	158	181	204	225	247	269	291	315	361	406	473	521	570	617
54	145	168	194	219	243	267	291	316	343	392	443	518	572	624	677
60	155	182	207	232	260	288	313	341	369	423	479	561	619	676	733
66	165	192	221	249	278	308	335	366	397	456	515	603	667	728	789
72	175	202	233	264	297	329	356	389	422	486	552	651	717	784	848
78	182	212	246	280	316	349	380	417	450	519	590	688	760	831	903
84	190	225	261	297	333	367	402	440	476	548	622	730	807	884	960
90	198	236	274	312	350	387	422	464	503	579	656	771	852	933	1015
96	207	246	287	327	366	406	444	485	529	609	691	811	897	981	1066
102	216	257	299	343	384	426	466	511	555	641	726	851	941	1020	1109
108	224	266	311	355	399	441	485	532	579	669	759	889	983	1061	1153
114	234	276	323	371	417	461	507	557	606	701	796	932	1022	1104	1200
120	242	287	337	386	435	480	529	583	633	732	832	976	1063	1148	1247
132	259	308	362	415	468	517	569	630	683	793	903	1015	1105	1193	1297
144	276	329	387	444	501	554	610	680	735	855	976	1056	1149	1242	1349
Cord Loop	52	55	57	62	64	66	68	74	78	83	88	95	101	107	110
Cordless	60	70	80	90	105	120	N/A								

Note: Shades measuring more than 96" in width are recommended as a Two-On-One Headrail shade.

Note: Shades measuring more than 72" in width are recommended with a Continuous Cord Loop Control.

Cellular Shade Surcharge Options:	
Cutouts	\$45.00 per cutout
Top-Down/Bottom-Up	\$60.00 (If Cordless, Add \$60.00 to cordless charge)
Top-Down Only	\$65.00 + Continuous Cord Loop surcharge
Day/Night	Price as the total of two separate shades
Two-On-One Headrail	\$20.00 Net (price as one overall shade)
Three-On-One Headrail	\$30.00 Net (price as one overall shade)
Fanned Angled Top or Angled Bottom	\$125.00
Arches & Specialty Shapes	\$125.00
Shades less than 102" in width shipped via FedEx: \$4.00 per unit Net Freight Charge	
Shades 102-1/8" to 125" in width shipped via FedEx: \$75.00 per unit Net Freight Charge	
Shades 125-1/8" or greater in width shipped via Common Carrier: \$ 150.00 per shipment	
All prices are in U.S. Dollars and do not include freight, duties or taxes for shipment to Alaska, Hawaii or Canada. GST and VAT are not included. Other restrictions and surcharges may apply. See freight Policy for complete details.	
Manufacturing specifications, options, surcharges and pricing are subject to change without notice.	

Visit [www.mariak.com](http://www.mariak.com) for the most recent downloads.



## Cellular Shades

### Suggested Retail Price Table #3

<b>Fabric</b>	<b>Colors</b>	<b>Fabric Width</b>	<b>Privacy Rating</b>	<b>Fabric Type</b>
7/16" Double Cell Spunlace	29	144"	Light Filtering	Spunlace

		Width														
		24	30	36	42	48	54	60	66	72	84	96	108	120	132	144
Length	36	142	161	183	205	226	246	265	286	305	350	395	460	506	550	593
	42	152	173	196	224	246	271	292	317	340	389	439	511	563	614	664
	48	162	187	214	241	266	292	318	344	372	426	480	559	615	673	729
	54	172	199	229	259	287	316	344	373	405	463	523	612	675	737	799
	60	183	215	245	274	307	340	370	403	436	500	566	662	731	798	865
	66	195	227	261	294	329	364	396	432	469	539	608	712	788	860	932
	72	207	239	275	312	351	389	421	460	498	574	652	769	847	926	1001
	78	215	251	291	331	373	412	449	493	531	613	697	812	897	981	1066
	84	225	266	308	351	393	434	475	520	562	647	734	862	953	1044	1133
	90	234	279	324	369	413	457	498	548	594	684	775	910	1006	1101	1198
	96	245	291	339	386	432	480	524	573	625	719	816	957	1059	1158	1258
	102	255	304	353	405	454	503	550	603	655	757	857	1005	1111	1204	1309
	108	265	314	367	419	471	521	573	628	684	790	896	1050	1160	1252	1361
	114	277	326	382	438	493	544	599	658	716	828	940	1100	1206	1303	1416
	120	286	339	398	456	514	567	625	688	747	864	982	1152	1255	1355	1472
	132	306	364	428	490	553	611	672	744	806	936	1066	1198	1304	1408	1531
144	326	389	457	524	592	654	720	803	868	1009	1152	1247	1356	1466	1592	
Cord Loop	52	55	57	62	64	66	68	74	78	83	88	95	101	107	110	
Cordless	60	70	80	90	105	120	N/A									

Note: Shades measuring more than 96" in width are recommended as a Two-On-One Headrail shade.

Note: Shades measuring more than 72" in width are recommended with a Continuous Cord Loop Control.

Cellular Shade Surcharge Options:	
Cutouts	\$45.00 per cutout
Top-Down/Bottom-Up	\$60.00 (If Cordless, Add \$60.00 to cordless charge)
Top-Down Only	\$65.00 + Continuous Cord Loop surcharge
Day/Night	Price as the total of two separate shades
Two-On-One Headrail	\$20.00 Net (price as one overall shade)
Three-On-One Headrail	\$30.00 Net (price as one overall shade)
Fanned Angled Top or Angled Bottom	\$125.00
Arches & Specialty Shapes	\$125.00
Shades less than 102" in width shipped via FedEx: \$4.00 per unit Net Freight Charge	
Shades 102-1/8" to 125" in width shipped via FedEx: \$75.00 per unit Net Freight Charge	
Shades 125-1/8" or greater in width shipped via Common Carrier: \$ 150.00 per shipment	
All prices are in U.S. Dollars and do not include freight, duties or taxes for shipment to Alaska, Hawaii or Canada. GST and VAT are not included. Other restrictions and surcharges may apply. See freight Policy for complete details.	
Manufacturing specifications, options, surcharges and pricing are subject to change without notice.	

Visit [www.mariak.com](http://www.mariak.com) for the most recent downloads.



## Cellular Shades

### Suggested Retail Price Table #4

Fabric	Colors	Fabric Width	Privacy Rating	Fabric Type
3/4" Single Cell Blackout	10	144"	Blackout	Composite

		Width														
		24	30	36	42	48	54	60	66	72	84	96	108	120	132	144
Length	36	168	190	216	242	267	291	313	338	360	413	467	543	598	649	700
	42	180	205	232	265	291	320	345	375	402	460	519	603	665	725	784
	48	192	221	253	285	314	345	376	406	439	503	567	660	726	795	861
	54	203	235	271	306	339	373	406	441	478	547	618	723	797	870	943
	60	216	254	290	324	363	402	437	476	515	590	668	782	863	942	1021
	66	231	268	308	347	389	430	468	510	554	637	718	841	930	1015	1100
	72	245	283	325	369	415	460	497	543	588	678	770	908	1000	1093	1182
	78	254	297	344	391	441	487	530	582	627	724	823	959	1059	1158	1258
	84	266	314	364	415	464	513	561	614	664	764	867	1018	1125	1232	1337
	90	277	330	383	436	488	540	588	647	701	808	915	1074	1188	1300	1414
	96	290	344	401	456	510	567	619	677	738	849	963	1130	1250	1367	1485
	102	301	359	417	478	536	594	649	712	773	894	1012	1186	1311	1421	1545
	108	313	371	434	495	556	615	677	742	808	933	1058	1239	1369	1478	1606
	114	327	385	451	517	582	642	707	777	845	978	1110	1298	1424	1538	1671
120	338	401	470	539	607	670	738	812	882	1020	1159	1360	1481	1599	1737	
132	362	430	506	579	653	721	793	878	952	1105	1258	1414	1539	1662	1807	
144	385	460	540	619	699	772	850	948	1025	1191	1360	1472	1601	1730	1879	
Cord Loop	52	55	57	62	64	66	68	74	78	83	88	95	101	107	110	
Cordless	60	70	80	90	105	120	N/A									

Note: Shades measuring more than 96" in width are recommended as a Two-On-One Headrail shade.

Note: Shades measuring more than 72" in width are recommended with a Continuous Cord Loop Control.

Cellular Shade Surcharge Options:	
Cutouts	\$45.00 per cutout
Top-Down/Bottom-Up	\$60.00 (If Cordless, Add \$60.00 to cordless charge)
Top-Down Only	\$65.00 + Continuous Cord Loop surcharge
Day/Night	Price as the total of two separate shades
Two-On-One Headrail	\$20.00 Net (price as one overall shade)
Three-On-One Headrail	\$30.00 Net (price as one overall shade)
Fanned Angled Top or Angled Bottom	\$125.00
Arches & Specialty Shapes	\$125.00
Shades less than 102" in width shipped via FedEx: \$4.00 per unit Net Freight Charge	
Shades 102-1/8" to 125" in width shipped via FedEx: \$75.00 per unit Net Freight Charge	
Shades 125-1/8" or greater in width shipped via Common Carrier: \$ 150.00 per shipment	
All prices are in U.S. Dollars and do not include freight, duties or taxes for shipment to Alaska, Hawaii or Canada. GST and VAT are not included. Other restrictions and surcharges may apply. See freight Policy for complete details.	
Manufacturing specifications, options, surcharges and pricing are subject to change without notice.	

Visit [www.mariak.com](http://www.mariak.com) for the most recent downloads.



## Cellular Shades

### Suggested Retail Price Table #5

<b>Fabric</b>	<b>Colors</b>	<b>Fabric Width</b>	<b>Privacy Rating</b>	<b>Fabric Type</b>
9/16" Single Cell Sheer	4	144"	Translucent	Sheer

		Width														
		24	30	36	42	48	54	60	66	72	84	96	108	120	132	144
Length	36	168	190	217	242	267	291	314	339	361	414	468	545	599	652	703
	42	179	204	232	265	291	321	346	375	403	461	521	606	668	728	787
	48	192	221	253	286	315	346	377	407	441	505	568	662	729	798	864
	54	203	235	272	307	340	374	407	442	480	549	620	725	801	874	948
	60	217	255	290	325	364	403	438	477	517	592	671	785	867	946	1026
	66	231	269	309	349	389	431	469	512	556	638	721	844	934	1019	1105
	72	245	283	326	370	416	461	498	545	591	680	773	911	1004	1098	1187
	78	255	297	344	392	442	489	532	584	630	727	826	963	1064	1163	1264
	84	266	315	365	416	466	514	563	616	666	767	871	1022	1130	1238	1344
	90	277	330	384	437	490	542	591	650	704	811	918	1079	1193	1306	1421
	96	290	344	402	458	512	568	622	679	741	853	967	1135	1256	1373	1492
	102	302	360	419	480	538	596	652	715	777	897	1016	1191	1317	1428	1553
	108	314	372	435	497	559	617	679	745	811	937	1063	1245	1376	1485	1614
	114	328	386	452	519	584	645	710	780	848	981	1114	1305	1431	1546	1680
	120	339	402	472	540	609	672	741	816	886	1025	1165	1366	1488	1607	1746
132	363	431	507	581	655	724	797	882	956	1110	1264	1421	1547	1670	1816	
144	386	461	542	622	701	776	854	952	1029	1197	1366	1478	1609	1739	1889	
Cord Loop	52	55	57	62	64	66	68	74	78	83	88	95	101	107	110	
Cordless	60	70	80	90	105	120	N/A									

Note: Shades measuring more than 96" in width are recommended as a Two-On-One Headrail shade.

Note: Shades measuring more than 72" in width are recommended with a Continuous Cord Loop Control.

Cellular Shade Surcharge Options:	
Cutouts	\$45.00 per cutout
Top-Down/Bottom-Up	\$60.00 (If Cordless, Add \$60.00 to cordless charge)
Top-Down Only	\$65.00 + Continuous Cord Loop surcharge
Day/Night	Price as the total of two separate shades
Two-On-One Headrail	\$20.00 Net (price as one overall shade)
Three-On-One Headrail	\$30.00 Net (price as one overall shade)
Fanned Angled Top or Angled Bottom	\$125.00
Arches & Specialty Shapes	\$125.00
Shades less than 102" in width shipped via FedEx: \$4.00 per unit Net Freight Charge	
Shades 102-1/8" to 125" in width shipped via FedEx: \$75.00 per unit Net Freight Charge	
Shades 125-1/8" or greater in width shipped via Common Carrier: \$ 150.00 per shipment	
All prices are in U.S. Dollars and do not include freight, duties or taxes for shipment to Alaska, Hawaii or Canada. GST and VAT are not included. Other restrictions and surcharges may apply. See freight Policy for complete details.	
Manufacturing specifications, options, surcharges and pricing are subject to change without notice.	

Visit [www.mariak.com](http://www.mariak.com) for the most recent downloads.

## Cellular Shades

### Suggested Retail Price Table #6

Fabric	Colors	Fabric Width	Privacy Rating	Fabric Type
9/16" Single Cell Crushed	5	144"	Light Filtering	Spunlace

		Width														
		24	30	36	42	48	54	60	66	72	84	96	108	120	132	144
Length	36	192	218	248	277	306	333	358	387	413	474	534	622	685	746	803
	42	205	234	266	302	333	366	395	429	461	526	595	693	763	832	899
	48	219	253	290	326	360	395	430	466	504	578	650	757	834	912	987
	54	232	269	310	350	389	427	466	506	549	627	709	829	915	998	1083
	60	248	291	331	371	416	461	501	546	590	677	766	898	990	1082	1173
	66	264	307	354	398	445	493	536	586	635	730	824	965	1067	1165	1262
	72	280	323	373	422	475	526	570	622	675	778	883	1042	1147	1254	1357
	78	291	339	394	448	506	558	608	667	720	830	944	1101	1216	1330	1445
	84	304	360	418	475	533	587	643	704	762	877	995	1168	1291	1414	1536
	90	317	378	438	499	560	619	675	742	805	926	1050	1234	1363	1493	1624
	96	331	394	459	523	586	650	710	776	846	974	1106	1298	1435	1570	1706
	102	346	411	478	549	614	682	746	818	888	1026	1162	1362	1506	1632	1774
	108	358	426	498	568	638	706	776	851	926	1070	1214	1422	1573	1698	1845
	114	374	442	517	594	667	738	811	891	970	1122	1274	1491	1635	1766	1920
	120	387	459	539	618	696	768	846	933	1013	1171	1331	1562	1701	1837	1995
	132	414	493	579	664	749	827	910	1008	1093	1269	1445	1624	1768	1909	2075
144	442	526	619	710	802	886	976	1088	1176	1368	1562	1690	1838	1987	2158	
Cord Loop	52	55	57	62	64	66	68	74	78	83	88	95	101	107	110	
Cordless	60	70		80		90		105		120	N/A					

Note: Shades measuring more than 96" in width are recommended as a Two-On-One Headrail shade.

Note: Shades measuring more than 72" in width are recommended with a Continuous Cord Loop Control.

Cellular Shade Surcharge Options:	
Cutouts	\$45.00 per cutout
Top-Down/Bottom-Up	\$60.00 (If Cordless, Add \$60.00 to cordless charge)
Top-Down Only	\$65.00 + Continuous Cord Loop surcharge
Day/Night	Price as the total of two separate shades
Two-On-One Headrail	\$20.00 Net (price as one overall shade)
Three-On-One Headrail	\$30.00 Net (price as one overall shade)
Fanned Angled Top or Angled Bottom	\$125.00
Arches & Specialty Shapes	\$125.00
Shades less than 102" in width shipped via FedEx: \$4.00 per unit Net Freight Charge	
Shades 102-1/8" to 125" in width shipped via FedEx: \$75.00 per unit Net Freight Charge	
Shades 125-1/8" or greater in width shipped via Common Carrier: \$ 150.00 per shipment	
All prices are in U.S. Dollars and do not include freight, duties or taxes for shipment to Alaska, Hawaii or Canada. GST and VAT are not included. Other restrictions and surcharges may apply. See freight Policy for complete details.	
Manufacturing specifications, options, surcharges and pricing are subject to change without notice.	

Visit [www.mariak.com](http://www.mariak.com) for the most recent downloads.

## Cellular Shades - Fire Retardant - Light Filtering

### Suggested Retail Price Table #7

Fabric	Colors	Fabric Width	Privacy Rating	Fabric Type
9/16" Single Cell Light Filtering FR	4	144"	Light Filtering	Flame Retardant

Part-Number & Color:	PLS310-001FR-Cotton LF PLS310-006FR-Fawn LF	PLS310-008FR-Pongee LF PLS310-070FR-Winter White LF
----------------------	--	--

		Width														
		24	30	36	42	48	54	60	66	72	84	96	108	120	132	144
Length	36	240	272	310	346	382	416	448	484	516	592	668	778	856	932	1004
	42	256	292	332	378	416	458	494	536	576	658	744	866	954	1040	1124
	48	274	316	362	408	450	494	538	582	630	722	812	946	1042	1140	1234
	54	290	336	388	438	486	534	582	632	686	784	886	1036	1144	1248	1354
	60	310	364	414	464	520	576	626	682	738	846	958	1122	1238	1352	1466
	66	330	384	442	498	556	616	670	732	794	912	1030	1206	1334	1456	1578
	72	350	404	466	528	594	658	712	778	844	972	1104	1302	1434	1568	1696
	78	364	424	492	560	632	698	760	834	900	1038	1180	1376	1520	1662	1806
	84	380	450	522	594	666	734	804	880	952	1096	1244	1460	1614	1768	1920
	90	396	472	548	624	700	774	844	928	1006	1158	1312	1542	1704	1866	2030
	96	414	492	574	654	732	812	888	970	1058	1218	1382	1622	1794	1962	2132
	102	432	514	598	686	768	852	932	1022	1110	1282	1452	1702	1882	2040	2218
	108	448	532	622	710	798	882	970	1064	1158	1338	1518	1778	1966	2122	2306
	114	468	552	646	742	834	922	1014	1114	1212	1402	1592	1864	2044	2208	2400
	120	484	574	674	772	870	960	1058	1166	1266	1464	1664	1952	2126	2296	2494
	132	518	616	724	830	936	1034	1138	1260	1366	1586	1806	2030	2210	2386	2594
144	552	658	774	888	1002	1108	1220	1360	1470	1710	1952	2112	2298	2484	2698	
Cord Loop	52	55	57	62	64	66	68	74	78	83	88	95	101	107	110	
Cordless	60	70	80	90	105	120	N/A									

Note: Shades measuring more than 96" in width are recommended as a Two-On-One Headrail shade.

Note: Shades measuring more than 72" in width are recommended with a Continuous Cord Loop Control.

Cellular Shade Surcharge Options:	
Cutouts	\$45.00 per cutout
Top-Down/Bottom-Up	\$60.00 (If Cordless, Add \$60.00 to cordless charge)
Top-Down Only	\$65.00 + Continuous Cord Loop surcharge
Day/Night	Price as the total of two separate shades
Two-On-One Headrail	\$20.00 Net (price as one overall shade)
Three-On-One Headrail	\$30.00 Net (price as one overall shade)
Fanned Angled Top or Angled Bottom	\$125.00
Arches & Specialty Shapes	\$125.00
Shades less than 102" in width shipped via FedEx: \$4.00 per unit Net Freight Charge	
Shades 102-1/8" to 125" in width shipped via FedEx: \$75.00 per unit Net Freight Charge	
Shades 125-1/8" or greater in width shipped via Common Carrier: \$ 150.00 per shipment	
All prices are in U.S. Dollars and do not include freight, duties or taxes for shipment to Alaska, Hawaii or Canada. GST and VAT are not included. Other restrictions and surcharges may apply. See freight Policy for complete details.	
Manufacturing specifications, options, surcharges and pricing are subject to change without notice.	

Visit [www.mariak.com](http://www.mariak.com) for the most recent downloads.



## Cellular Shades - Fire Retardant - Black Out

### Suggested Retail Price Table #8

Fabric	Colors	Fabric Width	Privacy Rating	Fabric Type
9/16" Single Cell Black Out FR	4	144"	Black Out	Flame Retardant

Part-Number & Color:	PLS320-001FR-Cotton BO PLS320-006FR-Fawn BO	PLS320-008FR-Pongee BO PLS320-070FR-Winter White BO
----------------------	--	--

		Width														
		24	30	36	42	48	54	60	66	72	84	96	108	120	132	144
Length	36	336	380	432	484	534	582	626	676	720	826	934	1086	1196	1298	1400
	42	360	410	464	530	582	640	690	750	804	920	1038	1206	1330	1450	1568
	48	384	442	506	570	628	690	752	812	878	1006	1134	1320	1452	1590	1722
	54	406	470	542	612	678	746	812	882	956	1094	1236	1446	1594	1740	1886
	60	432	508	580	648	726	804	874	952	1030	1180	1336	1564	1726	1884	2042
	66	462	536	616	694	778	860	936	1020	1108	1274	1436	1682	1860	2030	2200
	72	490	566	650	738	830	920	994	1086	1176	1356	1540	1816	2000	2186	2364
	78	508	594	688	782	882	974	1060	1164	1254	1448	1646	1918	2118	2316	2516
	84	532	628	728	830	928	1026	1122	1228	1328	1528	1734	2036	2250	2464	2674
	90	554	660	766	872	976	1080	1176	1294	1402	1616	1830	2148	2376	2600	2828
	96	580	688	802	912	1020	1134	1238	1354	1476	1698	1926	2260	2500	2734	2970
	102	602	718	834	956	1072	1188	1298	1424	1546	1788	2024	2372	2622	2842	3090
	108	626	742	868	990	1112	1230	1354	1484	1616	1866	2116	2478	2738	2956	3212
	114	654	770	902	1034	1164	1284	1414	1554	1690	1956	2220	2596	2848	3076	3342
	120	676	802	940	1078	1214	1340	1476	1624	1764	2040	2318	2720	2962	3198	3474
132	724	860	1012	1158	1306	1442	1586	1756	1904	2210	2516	2828	3078	3324	3614	
144	770	920	1080	1238	1398	1544	1700	1896	2050	2382	2720	2944	3202	3460	3758	
Cord Loop	52	55	57	62	64	66	68	74	78	83	88	95	101	107	110	
Cordless	60	70	80	90	105	120	N/A									

Note: Shades measuring more than 96" in width are recommended as a Two-On-One Headrail shade.

Note: Shades measuring more than 72" in width are recommended with a Continuous Cord Loop Control.

Cellular Shade Surcharge Options:	
Cutouts	\$45.00 per cutout
Top-Down/Bottom-Up	\$60.00 (If Cordless, Add \$60.00 to cordless charge)
Top-Down Only	\$65.00 + Continuous Cord Loop surcharge
Day/Night	Price as the total of two separate shades
Two-On-One Headrail	\$20.00 Net (price as one overall shade)
Three-On-One Headrail	\$30.00 Net (price as one overall shade)
Fanned Angled Top or Angled Bottom	\$125.00
Arches & Specialty Shapes	\$125.00
Shades less than 102" in width shipped via FedEx: \$4.00 per unit Net Freight Charge	
Shades 102-1/8" to 125" in width shipped via FedEx: \$75.00 per unit Net Freight Charge	
Shades 125-1/8" or greater in width shipped via Common Carrier: \$ 150.00 per shipment	
All prices are in U.S. Dollars and do not include freight, duties or taxes for shipment to Alaska, Hawaii or Canada. GST and VAT are not included. Other restrictions and surcharges may apply. See freight Policy for complete details.	
Manufacturing specifications, options, surcharges and pricing are subject to change without notice.	

Visit [www.mariak.com](http://www.mariak.com) for the most recent downloads.

06.05.13kb



575 West Manville Street, Rancho Dominguez, CA 90220  
 Customer Service Fax: (800) 459-6999 / International Fax: (310) 763-1749  
 PH: (800) 562-7425 / (310) 661-4400

## Purchase Order Cellular Shades - Custom Made

(Use Purchase Order form "CUT-DOWN Cellular Shades" for Ready-Made Cut-Down Cordless Cellulars)

Account #: \_\_\_\_\_ Company Name: \_\_\_\_\_ Contact: \_\_\_\_\_ Purchase Order #: \_\_\_\_\_

Ship To Address: \_\_\_\_\_ Phone: \_\_\_\_\_ Sidemark: \_\_\_\_\_

City: \_\_\_\_\_ State: \_\_\_\_\_ Zip: \_\_\_\_\_ Fax: \_\_\_\_\_ Date Required: \_\_\_\_\_

EMAIL: \_\_\_\_\_ Ship Via (circle one):      FedEX                      Common Carrier                      Mariak Truck                      Will Call

Line	Sidemark	Qty	Mount <sup>1</sup>	Width	Length	Shade Type <sup>2</sup>	Cell Type <sup>3</sup>	Color <sup>4</sup>	Lift <sup>5</sup>	Day / Night - Room Darkening Shade Color <sup>6</sup>	Hold Downs	Spacer Block
1												
2												
3												
4												
5												
6												
7												
8												
9												
10												

**Purchase Order Footnotes:**

<p><b>1. Mount:</b> (IM) - Inside Mount (OM) - Outside Mount</p> <p><b>2. Shade Type:</b> (PC) - Standard Pull Cord (Cord Lock Mechanism) (CCL) - Continuous Cord Loop (Clutch Mechanism) (CRDLSS) - Cordless (MTR) - Battery Powered Motorized (TDBU-PC) - Top-Down / Bottom-Up with Pull Cord Control (TD-CCL) - Top-Down Only with Continuous Cord Loop Control (TDBU-CRDLSS) - Top-Down / Bottom-Up with Cordless Control (DN-PC) - Day / Night with Pull Cord Control (2ON1-PC) - Two on One Headrail with Pull Cord Control (2ON1-CCL) - Two on One Headrail with Continuous Cord Loop Control (Specialty) - Specify the type of specialty shape and attach a drawing</p>	<p><b>3. Cell Type:</b> (9/16-SL) - 9/16" Single Cell Spunlace (3/4-SL) - 3/4" Single Cell Spunlace (7/16-SL) - 7/16" Double Cell Spunlace (9/16-PB) - 9/16" Single Cell Point-Bond (9/16-SH) - 9/16" Single Cell Sheer (9/16-CR) - 9/16" Single Cell Crushed (9/16-LN) - 9/16" Single Cell Linen Print Point-Bond (3/4-BO) - 3/4" Single Cell Blackout</p> <p>(9/16"-FRLF) - 9/16" Fire Retardant Light Filtering (9/16"-FRBO) - 9/16" Fire Retardant Blackout</p> <p><b>4. Color:</b> Specify the color # and name.</p> <p><b>5. Lift Cord Control:</b> (R) - Right Side Lift Cord (L) - Left Side Lift Cord</p> <p><b>6. Day / Night Color:</b> Specify the Blackout color # and name for the upper shade.</p>
---	---

# Mariak

Many Window Solutions From One Source

**BLANK PAGE**

575 West Manville Street  
Rancho Dominguez, CA 90220  
(800) 562-7425  
[www.mariak.com](http://www.mariak.com)