

# Mariak

Many Window Solutions From One Source

## West Lake Woven Wood Shade Section

Effective December 9, 2013



Save a life: "Install Safety Tension Devices!"

# Mariak

Many Window Solutions From One Source

## Woven Wood Measuring Instructions

### Measuring Inside Mount (IB) Shades:

Measure the exact width (A) and length (B) of the window opening as shown. The factory will deduct ½" overall from the window width for clearance. On all inside mount shades, a small light gap will be visible.

### Measuring Outside Mount (OB) Shades:

Measure the exact width (A) and length (B) of the window opening you wish to cover. The shade should cover the window opening by at least 2" on both the width and length. To cover a window sill, provide a measurement (C) beyond the sill.

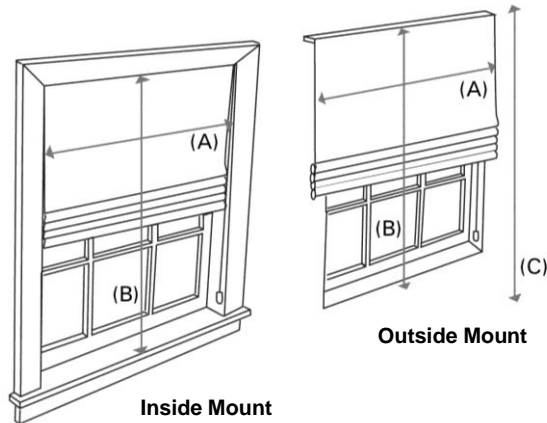

### Measuring Arch Top Valances for Woven Wood Shades:

For inside mount shades, measure the exact width and tallest length inside the window opening. For outside mount shades, measure the desired width and tallest length. Make sure to measure the length of outside mount shades at its tallest point. Arch Top woven wood shades must be perfect arches where the length equals ½ the width. For arch top valances, measure dimensions A, X, & Y. For pricing, use the width and tallest length measurement. Make sure to add the arch top shade surcharge.

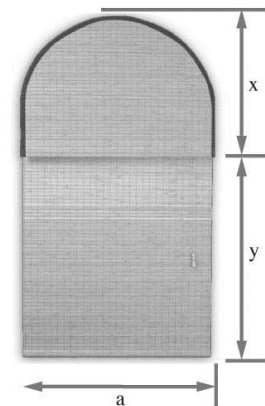

**Arch Top**

### Measuring Angled Shades:

It is critical to measure all four sides of the window opening. For inside mount shades, measure the inside of the window opening and for outside mount shades, add the desired overlap. Measure the slope angle with a protractor and provide the angle in degrees. Indicate all measurements on a template to be sent to the factory. For pricing, use the tallest length of the shade. For angle top valances, measure dimensions A, X, & Y. For pricing, use the width and tallest length measurement. Make sure to add the angled shade surcharge.

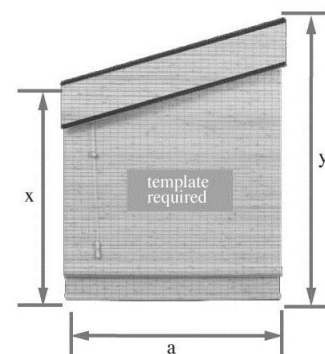

**Angle Top with  
Angled Valance**

# Mariak

Many Window Solutions From One Source

## Woven Wood Exploded Diagram

### Standard Style Woven Wood Shade

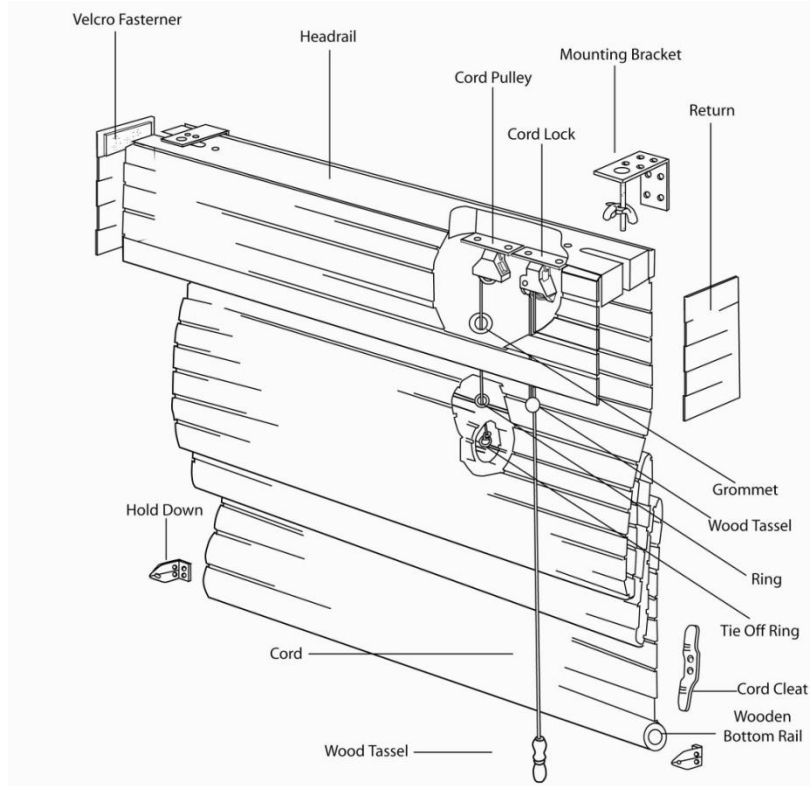

### Folding Door Style Woven Wood Shade

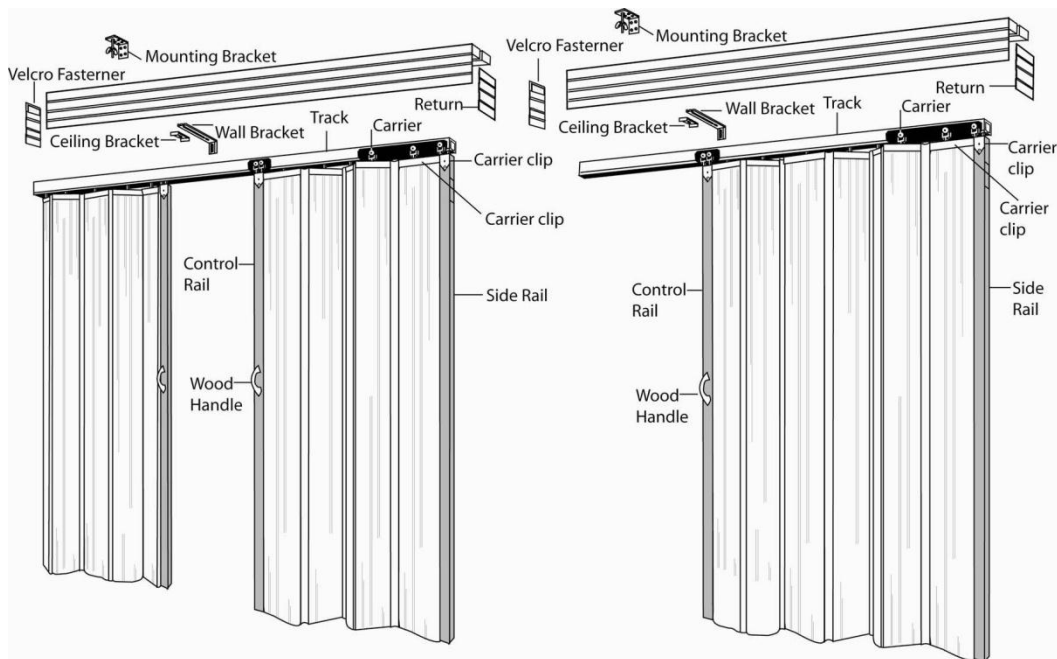

Split Draw

One Way Draw

# Mariak

Many Window Solutions From One Source

## Woven Wood Shade Options

### Standard Style Woven Wood Shade

The Standard Style woven wood shade has the lift control cord in *front* of the shade. When completely down, the shade lays flat covering the window. When raised, the material rises from the bottom in flat folds. This shade option includes a 6" valance.

Minimum Width: 12"  
Maximum Width: 96"  
Minimum Height: 12"  
Maximum Height: 108"

Optional Continuous Cord Loop is available.  
See Retail Price Tables for surcharge.

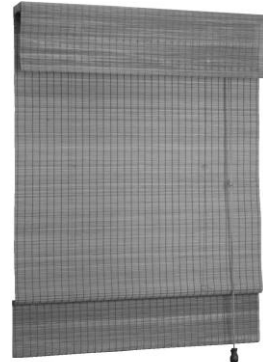

### Waterfall Style Woven Wood Shade

The Waterfall Style woven wood shade offers the lift control cord *behind* the shade. The material is attached to the front of the headrail without a valance. When completely down, the shade lays flat covering the window. When raised, the material rises from the bottom in flat folds.

Minimum Width: 12"  
Maximum Width: 96"  
Minimum Height: 12"  
Maximum Height: 108"

Optional Continuous Cord Loop is available.  
See Retail Price Tables for surcharge.

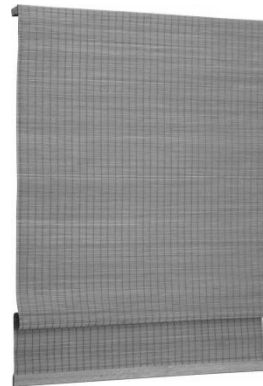

### Twin Style Woven Wood Shade

The Twin style shade features two separate, independently operated shades on one headrail. The front shade may be either a Standard Style shade or a Waterfall Style shade in natural woven wood material. A separate liner shade is attached to the back of the headrail. Both shades operate independently with lift cords at opposite sides of the shade. Available with Edge Binding and Wood Bars.

Minimum Width: 12"  
Maximum Width: 96"  
Minimum Height: 12"  
Maximum Height: 108"

Optional Continuous Cord Loop is available for both Front Shade only and for Front Shade and Back Liner. If this option is selected for both Front Shade and Back Liner, add the Cord Loop surcharge twice.  
See Retail Price Tables for surcharge.

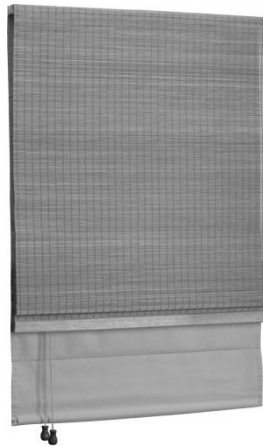

### Continuous Loop Style Woven Wood Shade

The continuous loop style woven wood shade has a clutch lift mechanism that provides easier lifting of the shade and eliminates cord tangling. The control cord for this style of shade will always remain the same length. This option is available for Standard, Waterfall, and Twin Style Shades. It features an automatic locking device, which allows the shade to be stopped at any position. This option is strongly recommended for very large or heavy woven wood shades.

Continuous Loop Surcharge...Price as a standard shade and add the surcharge listed at the bottom of each Suggested Retail Price Table.

Minimum Width: 18"  
Maximum Width: 96"  
Minimum Height: 12"  
Maximum Height: 108"

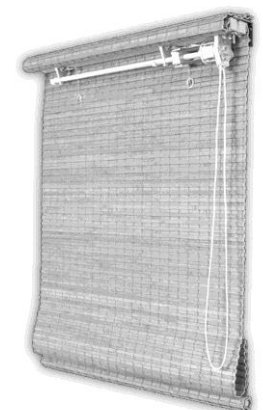

# Mariak

Many Window Solutions From One Source

## Top-Down/Bottom-Up Style Woven Wood Shade

The top-down/bottom-up style woven wood shade can be raised from the bottom or lowered from the top by two sets of lift cords located on opposite sides of the shade. The lift cords will be located in *front* of the shade. A 6" lined valance will be included to conceal the operating hardware and is included in the surcharge. When raised, the material rises from the bottom in flat folds. The top-down/bottom-up option is available with only with Standard Style shades.

Top-Down/Bottom-Up Surcharge.....\$ 45.00 Net Per Shade

Minimum Width: 18"  
Maximum Width: 60"  
Minimum Height: 18"  
Maximum Height: 72"

This option is not available for 3-On-1 headrail shades.  
This option is not available with Continuous Cord Loop.

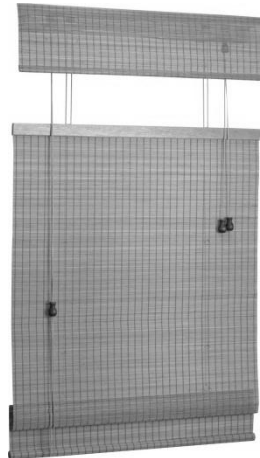

## Arch Top Style Woven Wood Shade

This shade option includes an arch top style valance. A coordinating edge binding trim is included for this valance and a template for the arch is required.

- Arch Top Surcharge.....\$60.00 Net Per Shade

Minimum Width: 18"  
Maximum Width: 72"  
Minimum Height: 18"  
Maximum Height: 72"

This option is not available with Continuous Cord Loop.

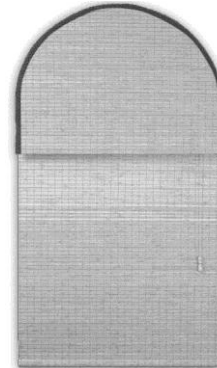

## Angle Top Style Woven Wood Shade

This shade option includes an angle top with an angled valance.

- Angle Top Surcharge.....\$ 40.00 Net Per Shade

Minimum Width: 18"  
Maximum Width: 72"  
Minimum Height: 18"  
Maximum Height: 72"

*This option is not available with Continuous Cord Loop.*

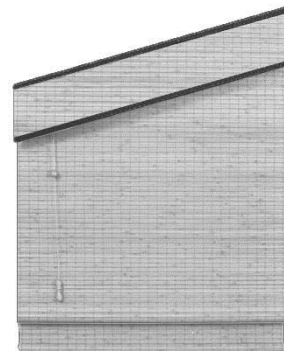

## Multiple Woven Wood Shades On One Headrail

The multiple shades on 1 headrail option is a reasonable choice for large openings. The opening width is split into 2 or 3 individual shades with one common valance. Price as one overall shade and add the applicable surcharge listed below.

- 2—on—1 Headrail Surcharge...\$ 20.00 Net Per Opening
- 3—on—1 Headrail Surcharge...\$ 25.00 Net Per Opening

Minimum Width: 36"  
Maximum Width: 96"  
Minimum Height: 18"  
Maximum Height: 108"

-Optional Continuous Cord Loop is available.  
-Maximum width for a common valance is 96".  
-Maximum light gap between shades will be 1/2".  
-See Retail Price Tables for surcharge.

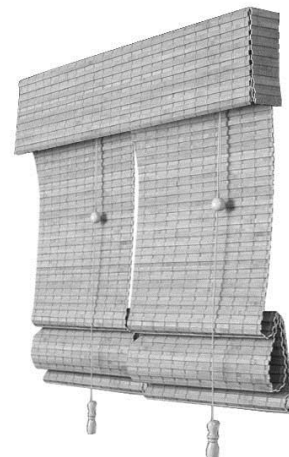

# Mariak

Many Window Solutions From One Source

## Folding Door Style Woven Wood Shade

The folding door style woven wood shade is optimal for sliding glass doors. They may also be used as room dividers. Folding door shades are only recommended for outside mount installations. Edge binding is not an available option for this style of shade. Please note that the fabric used for folding door shades are railroaded, or turned 90° sideways. A valance is not included, but is available for an additional surcharge. The direction of the fabric used to make the valance will be cut straight or opposite the way it appears in the folding door shade.

Minimum Width: 24"  
 Maximum Width: 192"  
 Minimum Height: 24"  
 Maximum Height: 96"

- Bamboo Wood Bars, handles & screws provided with each door.
- Available in One-Way Left or Right as standard.
- Center opening available for an additional surcharge.
- Standard 5% fullness; door lies nearly flat when fully extended.
- 20% Fullness options for an additional surcharge.
- Liners are available and will be attached to the top of the folding door and secured down both sides beneath the bamboo wood bars.
- Optional Valance is 8" long and is mounted to a wood board 5-1/2" deep and 3/4" thick. Attached to the front edge of the board by Velcro.
- Edge Binding is not available on Folding Door Shades.
- Inside Mount shades the valance will cover the front of the valance board only; Outside Mount shades the valance will wrap around both ends of the board.
- Bracket dimension is 3" Deep x 1-1/2" High

### Doors without a Valance –

The height of the folding door is measured from the top of the track to the bottom of the fabric. There is a gap of approximately 3/4" between the top of the track and the material. The factory will deduct this amount from the ordered length.

### Doors with a Valance –

The height of the folding door is measured from the top of the valance board to the bottom of the fabric. The valance board is 3/4" thick and there is 3/4" between the top of the track and the top of the material. The factory will deduct 1-1/2" from the ordered length.

### Inside Mount Measurements –

Minimum Inside Mount Depth is 2"  
 Check for any obstructions such as trim or handles that may interfere with the opening and closing of the door.

### Inside Mount Deductions:

Width: 1/4" Height: 3/4"

No deductions are made to the width or height of Outside Mount Door.

| STACK CHART |        |
|-------------|--------|
| 5% Fullness |        |
| Width       | Stack  |
| 36"         | 8-1/2" |
| 42"         | 9"     |
| 48"         | 9-1/2" |
| 60"         | 11"    |
| 72"         | 12"    |
| 84"         | 13"    |
| 96"         | 14"    |

Center opening shades will open into two equal stacks on each side.

20% Fullness shades will stack approximately 1" wider for small shades and 1-1/2" wider for larger shades.

All stacking dimensions are approximate and will vary by pattern

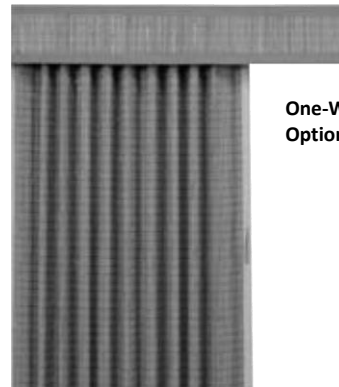

One-Way Left Stack with Optional Valance



Center Opening with Optional Valance



Center Opening shown without valance



5% Fullness

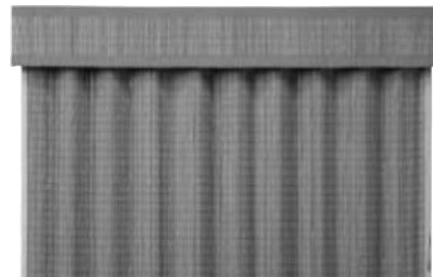

20% Fullness

# Mariak

Many Window Solutions From One Source

## Lining Options:

### **Privacy Lining:**

Provides complete privacy & filters light by more than 50%.

### **Black-Out Lining:**

Provides complete privacy and blocks sunlight with the exception of side light gaps.

**Surcharges will apply.**



## Wood Bottom Bars:

Available with all patterns and up to 96" wide. Not available with Edge Binding. Tassels will be coordinated to the pattern and cords, not to the wood bar.

**Surcharges will apply.**

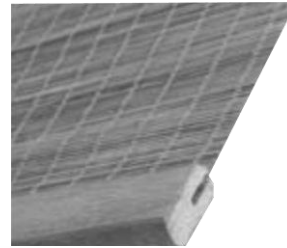

## Edge Binding Options:

Edge binding is an excellent method of both protecting the ends of the shade fabric and adding a color accent to the shade. Wide Edge binding is 3" in width (1 1/2" on the face of the shade). Narrow Edge Binding is 1-1/2" (3/4" on the face of the shade). It is applied to the sides of the shade and valance and (if applicable) across the bottom of the shade.

- Not available with Hold Downs or Wood Bottom Bars.

**Surcharges will apply.**

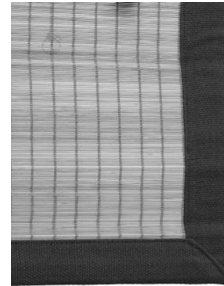

# Mariak

Many Window Solutions From One Source

## Woven Wood Shade Motorization

### Motorized Woven Wood Shade

Woven Wood Shades can be powered by a variety of motors. At the press of a button, shades can be raised up, exposing a room to sunlight, or lowered down, Filtering Light from a room. Motorized Woven Woods will have a lift cord in back; the motor is in a tube and the cords roll-up onto the tube.



**RF Hand-Held Transmitters & Wireless Wall Switches are available in 1 & 5 Channel models**

#### Battery Powered Radio Frequency Motors:

Smaller shades may be operated by a battery powered motor system. This unique motor system has full lift control of shades that are up to 12.5 lbs. The motor is powered by AA lithium battery packs, which can be mounted to the ceiling or installed to the wall. The battery life expectancy is 1 to 2 years (based upon 2 operations per day and the weight of the shade). Battery Powered Woven Wood Shades are available with radio frequency controls. These motors have a built-in radio frequency receiver that communicates with a hand held remote control transmitter or a wireless wall switch via radio waves. Woven Wood Shades controlled by radio frequency may be operated as an individual unit, as sub-groups, and as an entire group. Please consult Mariak technical support with any questions you may have.

|                 |     |   |                        |
|-----------------|-----|---|------------------------|
| Minimum Width:  | 24" | <b>Battery Powered Motor Surcharges:</b>          |                        |
| Maximum Width:  | 72" | Battery Powered Motor (Radio Frequency – 12 Volt) | \$400.00 (Net Pricing) |
| Minimum Height: | 24" | Radio Frequency Transmitter 1-Ch                  | \$ 61.00 (Net Pricing) |
| Maximum Height: | 72" | Radio Frequency Transmitter 5-Ch                  | \$ 80.00 (Net Pricing) |
|                 |     | Radio Frequency Wireless Wall Switch 1-Ch         | \$146.00 (Net Pricing) |
|                 |     | Radio Frequency Wireless Wall Switch 5-Ch         | \$153.00 (Net Pricing) |

#### 24-Volt DC (Low Voltage) Powered Plug-In or Hardwired Radio Frequency Motors:

This Woven Wood Shade is operated by a 24-volt DC 2-wire motor. The motor may be plugged-in to a standard electrical wall outlet with a 24-volt transformer or hardwired via low voltage wiring if desired. A variety of low voltage transformers are available for an additional charge. These motors have a built-in radio frequency receiver that communicates with a hand held remote control transmitter or a wireless wall switch via radio waves. The electronic controls for this type of motor are capable of operating a shade individually, as sub-groups, and as an entire group. Please consult Mariak technical support with any questions you may have.

|                 |     |   |                        |
|-----------------|-----|---|------------------------|
| Minimum Width:  | 24" | <b>24-Volt DC (Low Voltage) Powered Motor Surcharges:</b> |                        |
| Maximum Width:  | 96" | DC Powered Motor (Radio Frequency – 12 Volt)              | \$415.00 (Net Pricing) |
| Minimum Height: | 24" | Radio Frequency Transmitter 1-Ch                          | \$ 61.00 (Net Pricing) |
| Maximum Height: | 96" | Radio Frequency Transmitter 5-Ch                          | \$ 80.00 (Net Pricing) |
|                 |     | Radio Frequency Wireless Wall Switch 1-Ch                 | \$146.00 (Net Pricing) |
|                 |     | Radio Frequency Wireless Wall Switch 5-Ch                 | \$153.00 (Net Pricing) |

*Please consult Mariak technical support for assistance with selecting and pricing the appropriate low voltage transformer.*

**110-Volt AC Powered Plug-In Radio Frequency Motors: (Most Popular Motor Option!)** This Woven Wood Shade is operated by a 110-volt AC 3-wire motor. The motor may be plugged-in to a standard 3-prong electrical wall outlet or hardwired if desired. For your convenience, the shade is shipped from the factory with a plug installed at the end of the motor cable. If so desired, the plug may be cut off and hardwired to a dedicated power supply by a licensed electrician. These motors have a built-in radio frequency receiver that communicates with a hand held remote control transmitter or a wireless wall switch via radio waves. The electronic controls for this type of motor are capable of operating a shade individually, as sub-groups, and as an entire group. Please consult Mariak technical support with any questions you may have.

|                 |     |  |                        |
|-----------------|-----|--|------------------------|
| Minimum Width:  | 30" | <b>110-Volt AC Powered Plug-In Radio Frequency Motor Surcharges:</b> |                        |
| Maximum Width:  | 96" | AC Powered Plug-In Motor (Radio Frequency – 110 Volt)                | \$420.00 (Net Pricing) |
| Minimum Height: | 24" | Radio Frequency Transmitter 1-Ch                                     | \$ 61.00 (Net Pricing) |
| Maximum Height: | 96" | Radio Frequency Transmitter 5-Ch                                     | \$ 80.00 (Net Pricing) |
|                 |     | Radio Frequency Wireless Wall Switch 1-Ch                            | \$146.00 (Net Pricing) |
|                 |     | Radio Frequency Wireless Wall Switch 5-Ch                            | \$153.00 (Net Pricing) |

#### 110-Volt AC Powered Standard Hardwired Motors:

This Woven Wood Shade is operated by a 110-volt AC 4-wire motor. It requires the motor to be hardwired or installed such that the power supply must be fixed and permanent. In other words, wires from a power source within the wall must be connected by a licensed electrician so that the motor receives a constant power supply at all times. A variety of electronic controls for hardwired motorized Woven Wood Shades are capable of operating a shade individually, as sub-groups, and/or as an entire group. Please consult Mariak technical support with any questions you may have.

|                 |     |   |                        |
|-----------------|-----|---|------------------------|
| Minimum Width:  | 30" | <b>110-Volt AC Powered Standard Hardwired Motor Surcharges:</b>                   |                        |
| Maximum Width:  | 96" | AC Powered Plug-In Motor (Hardwired – 110 Volt)                                   | \$385.00 (Net Pricing) |
| Minimum Height: | 24" | Basic Wall Switch   | \$ 20.00 (Net Pricing) |
| Maximum Height: | 96" | (A wide variety of hardwired motor group controllers are available upon request.) |                        |



## Additional Woven Wood Shade Information

**Factory Deductions:** Inside mount shades have a  $\frac{3}{8}$ " deduction in width.

### Fabric Information:

**Yarns** – A wide array of natural and manmade fibers are used in the making of the yarns featured in woven wood fabrics. Pure, bright colors are achieved by using the finest dyes available. Even so, over a period of time slight fading may occur.

**Stretching** – All natural woven wood shades may stretch; this is an inherent trait for these fabrics.

**Color Variation** – Both the paints and stains on natural fabrics are subject to color variation. Reed and wood slats will retain the unique grain, nodes, color, and shape irregularities inherent from natural woods, water reeds, and grasses.

**Fading** – Over an extended period of time, exterior and interior discoloration may occur. The colors may become more yellow after exposed to strong sunlight. The use of a privacy lining will minimize fading.

**Stretching, Color Variation, and Fading are natural characteristics of woven wood shades. The occurrence of these changes is industry standard and will not warrant a replacement shade.**

**Energy Savings** – Woven wood fabrics are a good insulator against the summer's heat and winter's cold.

### Headrail Dimensions:

| Headrail Type   | Dimensions |
|---|------------|
| Standard Pull Cord (Cord Lock) Woven Wood Shades  | 1 ½" x ¾"  |
| Continuous Cord Loop, Battery Motors, & DC (Low Voltage) Motors<br>Twin Shade with Standard Pull Cord for both Front Shade & Back Liner | 2 ½" x ¾"  |
| AC (High Voltage) Motorized Woven Wood Shades<br>Twin Shade with Cord Loop Front Shade & Pull Cord Back Liner                           | 3" x ¾"    |
| Twin Shade with Cord Loop for both Front Shade & Back Liner   | 5" x ¾"    |

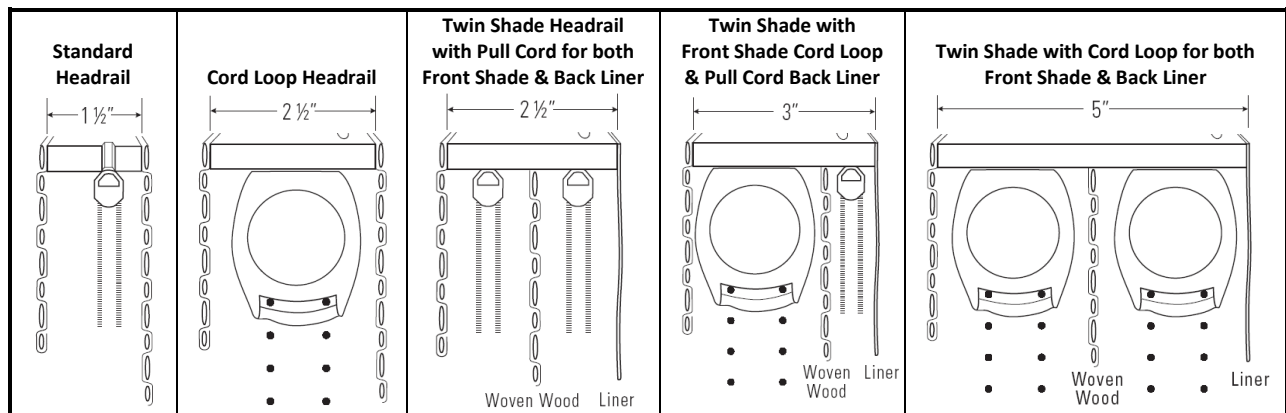

### Stack Height Chart:

| Height of Shade | Total Thickness        |
|-----------------|------------------------|
|                 | Traditional Roman Fold |
| Up To ~84"      | ~9"                    |
| 85 - 120"       | ~10"                   |

Note: These are estimated measurements and may vary from shade type to shade type and fabric to fabric.

### Cleaning Instructions:

Woven wood shades are designed to be durable and are easily cleaned. These fabrics are inherently anti-static and repel dust. Occasional feather dusting or light vacuuming may be necessary to keep the fabrics clean and bright.

# Mariak

Many Window Solutions From One Source

## Bracket Dimensions

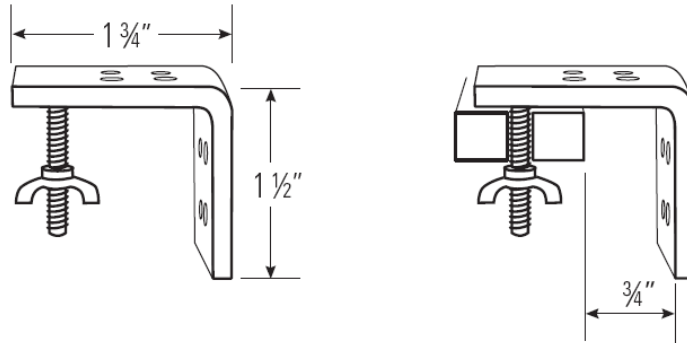

### Inside Mount Depths:

**Minimum Required Depth:** 3/4" with standard bracket

**Flush Mount Required Depth:** Headrail size plus 1" if using standard bracket.

Exact flush inside mount depths will vary slightly based upon the thickness of the fabric selected.

### Safety Information:

To insure child safety, it is strongly recommended that each shade be installed with a cord safety cleat provided by the manufacturer.

### No Charge Options:

Valance returns are supplied with all outside mount shades and are available upon request with inside mount shades.

Standard valance returns are 6" long and are made of the bamboo pattern chosen.

Hold-Down Brackets are available upon request, but are not available with Edge Binding or Wood Bottom Bar options.

Spacer Blocks are available upon request.

### Fabric Valance Returns:

For shades with edge binding, returns made from the edge binding fabric are available as a surcharge option.

### Lined Valance:

Lined valances are recommended to conceal the headrail components when an open-weave pattern is selected. This is particularly recommended if clutch controls are chosen as these components are more visible through the valance. All Top-Down/Bottom-Up shades will be shipped with lined valance as standard.

### Cut Outs:

Cut outs can be taken from either side of the shade. Please provide exact dimensions and the locations of the cut outs required. There may be limitations to what can be cut out, based on the size and specifications of the shade.

### Cord Shrouds:

Cords on the back of the shade are wrapped in a "cord shroud" for increased safety against strangulation hazard. This allows the shade to fold normally, but does not allow a hazardous loop to be formed since the lift cord cannot be pulled out on the back of the shade any further than the spacing between the lift rings.



Surcharge of \$ 1.50 per shade will automatically be applied to all Woven Wood Shades.

In compliance with the latest manufacturing safety guidelines Mariak Window Fashions includes with each fully-assembled product warning tags, warning labels, safety devices and cord cleats. Installers of the finished product must adhere to the safety guidelines as established by the installation instructions and by using all devices provided by the manufacturer. It is the responsibility of the installer, as well as the end consumer, to see that all safety devices are properly installed according to the manufacturers installation instructions included with each device and remain so throughout the life of the product. Mariak Window Fashions is not liable for injuries or fatal occurrences related to improper installation or maintenance of required safety devices.



# Mariak

Many Window Solutions From One Source

## West Lake Woven Wood Pattern Index

| Pattern              | Color Code | Price Table | Edge Binding                       | Folding Door | Recommended Wood Bottom Bar Color |
|----------------------|------------|-------------|------------------------------------|--------------|-----------------------------------|
| ABACA BEIGE          | WL 8811B   | D           | *Y (Wide Edge Binding Recommended) | N/A          | Sugar Maple                       |
| ABACA EARTH          | WL 7231E   | D           | *Y (Wide Edge Binding Recommended) | Y            | Walnut                            |
| ABACA RED EARTH      | WL 8811R   | D           | *Y (Wide Edge Binding Recommended) | N/A          | Spice                             |
| ABACA SAGE           | WL 8813S   | D           | *Y (Wide Edge Binding Recommended) | N/A          | Driftwood                         |
| AKITA CARBON         | WL 3100R   | C           | Y                                  | Y            | Sugar Maple                       |
| AKITA HAZELNUT       | WL 3030H   | C           | Y                                  | Y            | Espresso                          |
| AKITA OAK            | WL 3010K   | C           | Y                                  | Y            | Walnut                            |
| AKITA WALNUT         | WL 3050W   | C           | Y                                  | Y            | Walnut                            |
| ASPEN WALNUT         | WL 8082W   | B           | Y                                  | Y            | Spice                             |
| BAJA SAND            | WL 8051S   | A           | Y                                  | Y            | Natural                           |
| BAMBOO FOREST GREEN  | WL 0122G   | C           | Y                                  | Y            | Sugar Maple                       |
| BAMBOO PALM CARBON   | WL 4100R   | C           | Y                                  | Y            | Driftwood                         |
| BAMBOO PALM DARK OAK | WL 4100D   | C           | Y                                  | Y            | Spice                             |
| BAMBOO PALM ESPRESSO | WL 4100E   | C           | Y                                  | Y            | Espresso                          |
| BAMBOO PALM WALNUT   | WL 4100W   | C           | Y                                  | Y            | Spice                             |
| BAMBOO REEDS WHEAT   | WL 2040W   | B           | N/A                                | N/A          | Natural                           |
| BAMBOO WEAVE CAMEL   | WL 2060C   | B           | N/A                                | N/A          | Sugar Maple                       |
| BORA BORA NATURAL    | WL 8861N   | B           | Y (Edge Binding Recommended)       | Y            | Natural                           |
| CABANA PECAN         | WL 8036P   | B           | Y                                  | Y            | Spice                             |
| CABANA SADDLE        | WL 8036S   | B           | Y                                  | Y            | Sugar Maple                       |
| CARIBE SPICE         | WL 5243S   | D           | *Y                                 | N/A          | Walnut                            |
| CORONADO WHITE SAND  | WL 8056W   | D           | Y (Wide Edge Binding Recommended)  | N/A          | Natural                           |
| DRIFTWOOD NATURAL    | WL 5068N   | A           | Y                                  | Y            | Natural                           |
| FIJI NATURAL         | WL 0121N   | A           | Y                                  | Y            | Natural                           |
| FOREST GRASS SAGE    | WL 0235S   | C           | *Y                                 | Y            | Driftwood                         |
| HANA NATURAL         | WL 8025N   | C           | *Y                                 | Y            | Natural                           |
| HARMONY NATURAL      | WL 4970N   | D           | *Y                                 | N/A          | Natural                           |
| HARMONY SPICE        | WL 4970S   | D           | *Y                                 | N/A          | Walnut                            |
| KOWLOON BAY          | WL 8050K   | B           | Y                                  | Y            | Sugar Maple                       |
| KYOTO BROWN          | WL 5646B   | A           | Y                                  | Y            | Walnut                            |
| KYOTO MERLOT         | WL 5647M   | A           | Y                                  | Y            | Spice                             |
| LAGUNA UMBER         | WL 8867U   | A           | N/A                                | N/A          | Sugar Maple                       |
| LATTICE TWILIGHT     | WL 8074D   | A           | Y                                  | Y            | Espresso                          |
| MANDALAY OAK         | WL 5087K   | A           | Y                                  | Y            | Sugar Maple                       |
| MANDALAY PISTACHIO   | WL 5052P   | A           | Y                                  | Y            | Natural                           |
| MEDAN CARMEL         | WL 5056C   | A           | Y                                  | N/A          | Sugar Maple                       |
| MONTEREY OAK         | WL 6914K   | A           | Y                                  | Y            | Sugar Maple                       |
| NOCTURNE EBONY       | WL 5186E   | B           | Y                                  | Y            | Natural                           |
| PANAMA CEDAR         | WL 8044C   | A           | Y                                  | Y            | Spice                             |
| PARCHMENT BLEACHED   | WL 7253B   | C           | Y (Wide Edge Binding Recommended)  | N/A          | Natural                           |
| PENANG OAK           | WL 5057K   | A           | Y                                  | Y            | Sugar Maple                       |
| PRAIRIE BRUSHWOOD    | WL 0209B   | C           | *Y                                 | N/A          | Walnut                            |
| PRAIRIE NATURAL      | WL 7249N   | D           | *Y                                 | N/A          | Driftwood                         |
| PRAIRIE RUSSET       | WL 7254R   | D           | *Y                                 | N/A          | Spice                             |
| RAFFIA BARK          | WL 7252B   | D           | *Y                                 | N/A          | Walnut                            |

# Mariak

Many Window Solutions From One Source

## West Lake Woven Wood Pattern Index (continued)

| Pattern               | Color Code | Price Table | Edge Binding                 | Folding Door | Recommended Wood Bottom Bar |
|-----------------------|------------|-------------|------------------------------|--------------|-----------------------------|
| RUSTIC PECAN          | WL 8021P   | A           | Y                            | Y            | Walnut                      |
| RUSTIC TAN            | WL 8017T   | A           | Y                            | Y            | Sugar Maple                 |
| SAVANNA NIGHTSHADE    | WL 7415N   | D           | *Y                           | N/A          | Espresso                    |
| ST. MARTIN CAPPUCCINO | WL 8031C   | D           | Y (Edge Binding Recommended) | Y            | Walnut                      |
| SUMATRA ESPRESSO      | WL 5002E   | B           | Y                            | N/A          | Espresso                    |
| SUMATRA SADDLE        | WL 5002S   | B           | Y                            | N/A          | Walnut                      |
| SUN SHADE BROWN       | WL 5049B   | B           | Y                            | Y            | Walnut                      |
| SUN SHADE NATURAL     | WL 5049N   | B           | Y                            | Y            | Natural                     |
| SUN SHADE WHITE       | WL 5049W   | C           | Y                            | N/A          | Natural                     |
| TAMARIND BROWN        | WL 7248B   | C           | Y                            | Y            | Spice                       |
| TERRA OAK             | WL 9077K   | D           | *Y                           | Y            | Sugar Maple                 |
| TIKI CARBON           | WL 0120C   | A           | Y                            | Y            | Walnut                      |
| WESTPORT NUTMEG       | WL 8865N   | B           | *Y                           | N            | Spice                       |

*Edge binding is recommended on certain fabrics as the edges can become easily damaged and the treads tend to unravel.*

*\*Narrow edge binding not recommended with these patterns.*

### Edge Binding Color Reference

|                             |            |
|-----------------------------|------------|
| CREAM                       | T001, W001 |
| DARK BEIGE                  | T003, W003 |
| DESERT SAND                 | T005, W005 |
| MOCHA                       | T007, W007 |
| PECAN                       | T009, W009 |
| CHOCOLATE                   | T010, W010 |
| KHAKI                       | T012, W012 |
| LIGHT OLIVE                 | T013, W013 |
| BERRY                       | T014, W014 |
| BLACK                       | T015, W015 |
| <b>T - Narrow    W-Wide</b> |            |

### Wood Bar Color Reference

|             |      |
|-------------|------|
| WALNUT      | WB03 |
| DRIFTWOOD   | WB05 |
| NATURAL     | WB06 |
| SPICE       | WB10 |
| ESPRESSO    | WB14 |
| SUGAR MAPLE | WB15 |

### Liner Color Reference

| Liner Color Name     | Color Number | Backing Color |
|----------------------|--------------|---------------|
| PRIVACY NATURAL      | FL4          | NATURAL       |
| PRIVACY BEIGE        | FL8          | BEIGE         |
| PRIVACY COCOA        | FL5          | COCOA         |
| PRIVACY WHITE        | FL7          | WHITE         |
| BLACK-OUT SOFT WHITE | FL9          | WHITE         |
| BLACK-OUT BEIGE      | FL2          | OFF WHITE     |

## West Lake Woven Wood Shades Standard & Waterfall Style Shades

**Suggested Retail Price - Table A**

| Width                                | 24  | 30  | 36  | 42  | 48  | 60  | 72  | 84  | 96  |
|--------------------------------------|-----|-----|-----|-----|-----|-----|-----|-----|-----|
| 36                                   | 94  | 119 | 145 | 162 | 180 | 222 | 250 | 291 | 320 |
| 48                                   | 132 | 152 | 171 | 194 | 214 | 267 | 299 | 350 | 386 |
| 54                                   | 141 | 171 | 185 | 207 | 234 | 290 | 330 | 378 | 421 |
| 60                                   | 149 | 178 | 200 | 222 | 244 | 309 | 362 | 406 | 456 |
| 66                                   | 157 | 185 | 214 | 237 | 263 | 353 | 389 | 448 | 504 |
| 72                                   | 165 | 196 | 228 | 253 | 279 | 369 | 410 | 491 | 551 |
| 78                                   | 176 | 209 | 242 | 273 | 304 | 392 | 444 | 520 | 586 |
| 84                                   | 186 | 222 | 257 | 291 | 330 | 415 | 468 | 551 | 628 |
| 90                                   | 195 | 233 | 271 | 307 | 345 | 449 | 522 | 594 | 675 |
| 96                                   | 204 | 245 | 286 | 324 | 362 | 473 | 542 | 632 | 720 |
| 108                                  | 230 | 276 | 322 | 365 | 407 | 532 | 609 | 711 | 810 |
| Roll Ease Cord Loop<br>Clutch System | 90  | 105 | 120 | 130 | 135 | 140 | 150 | 160 | 170 |
| Wood Bottom Bar                      | 13  | 16  | 18  | 20  | 22  | 27  | 31  | 36  | 40  |

Note: Shades measuring more than 72" in width are recommended with a continuous cord loop control.

|                   |                    |              |             |
|-------------------|--------------------|--------------|-------------|
| Baja Sand         | Laguna Umber       | Monterey Oak | Tiki Carbon |
| Driftwood Natural | Lattice Twilight   | Panama Cedar |             |
| Fiji Natural      | Mandalay Oak       | Penang Oak   |             |
| Kyoto Brown       | Mandalay Pistachio | Rustic Pecan |             |
| Kyoto Merlot      | Medan Camel        | Rustic Tan   |             |

| <b>Woven Wood Surcharge Options</b>  |  |           |             |
|--|--|-----------|-------------|
| Top-Down/Bottom-Up   | \$45.00 Net                              | Arch Top  | \$60.00 Net |
| Edge Binding Fabric Valance Returns  | \$15.00 Net                              | Angle Top | \$40.00 Net |
| Custom Cord Loop Length  | \$20.00 Net                              |           |             |
| Metal Bead Chain   | \$20.00 Net                              |           |             |
| Cutouts  | \$15.00 Net Per Cutout                   |           |             |
| Two-On-One Headrail  | \$20.00 Net (price as one overall shade) |           |             |
| Three-On-One Headrail  | \$25.00 Net (price as one overall shade) |           |             |
| Liners - Refer to Liner Price Tables   |  |           |             |
| Edge Binding - Refer to Edge Binding Price Tables  |  |           |             |
| Shades up to 102" in width shipped via FedEx: \$ 4.00 per unit Net Freight Charge        |  |           |             |
| Shades 102-1/8" to 125" in width shipped via FedEx: \$ 75.00 per unit Net Freight Charge |  |           |             |
| Shades 125" or greater in width shipped via Common Carrier: \$ 150.00 per shipment       |  |           |             |

|  |
|--|
| <b>Surcharge of \$ 1.50 per shade will automatically be applied to all Woven Wood Shades for Cord Shrouds.</b>   |
| All prices are in U.S. dollars and do not include freight, duties or taxes for shipment to Alaska, Hawaii or Canada. GST and VAT are not included. Other restrictions and surcharges may apply. See freight policy for complete details. |
| <b>Manufacturing specifications, options, surcharges and pricing are subject to change without notice.</b>   |

Visit [www.mariak.com](http://www.mariak.com) for most recent downloads.

## West Lake Woven Wood Shades Standard & Waterfall Style Shades

**Suggested Retail Price - Table B**

| Width                                | 24  | 30  | 36  | 42  | 48  | 60  | 72  | 84  | 96  |
|--------------------------------------|-----|-----|-----|-----|-----|-----|-----|-----|-----|
| 36                                   | 128 | 155 | 182 | 198 | 214 | 250 | 285 | 335 | 381 |
| 48                                   | 170 | 196 | 222 | 244 | 266 | 303 | 342 | 406 | 475 |
| 54                                   | 177 | 207 | 236 | 261 | 285 | 328 | 371 | 441 | 510 |
| 60                                   | 186 | 218 | 250 | 277 | 303 | 353 | 400 | 475 | 545 |
| 66                                   | 196 | 231 | 265 | 294 | 323 | 377 | 430 | 507 | 579 |
| 72                                   | 206 | 243 | 280 | 311 | 342 | 400 | 460 | 539 | 612 |
| 78                                   | 215 | 255 | 295 | 329 | 362 | 425 | 489 | 570 | 648 |
| 84                                   | 224 | 267 | 309 | 345 | 381 | 450 | 518 | 601 | 683 |
| 90                                   | 235 | 280 | 324 | 362 | 400 | 485 | 560 | 648 | 733 |
| 96                                   | 245 | 305 | 338 | 379 | 419 | 520 | 602 | 694 | 783 |
| 108                                  | 276 | 329 | 380 | 426 | 471 | 585 | 677 | 781 | 880 |
| Roll Ease Cord Loop<br>Clutch System | 90  | 105 | 120 | 130 | 135 | 140 | 150 | 160 | 170 |
| Wood Bottom Bar                      | 13  | 16  | 18  | 20  | 22  | 27  | 31  | 36  | 40  |

Note: Shades measuring more than 72" in width are recommended with a continuous cord loop control.

|                    |               |                   |                 |
|--------------------|---------------|-------------------|-----------------|
| Aspen Walnut       | Cabana Pecan  | Sumatra Espresso  | Westport Nutmeg |
| Bamboo Reeds Wheat | Cabana Saddle | Sumatra Saddle    |                 |
| Bamboo Weave Camel | Kowloon Bay   | Sun Shade Brown   |                 |
| *Bora Bora Natural | Noctune Ebony | Sun Shade Natural |                 |

\* Edge Binding Recommended

| <b>Woven Wood Surcharge Options</b>  |  |           |             |
|--|--|-----------|-------------|
| Top-Down/Bottom-Up   | \$45.00 Net                              | Arch Top  | \$60.00 Net |
| Edge Binding Fabric Valance Returns  | \$15.00 Net                              | Angle Top | \$40.00 Net |
| Custom Cord Loop Length  | \$20.00 Net                              |           |             |
| Metal Bead Chain   | \$20.00 Net                              |           |             |
| Cutouts  | \$15.00 Net Per Cutout                   |           |             |
| Two-On-One Headrail  | \$20.00 Net (price as one overall shade) |           |             |
| Three-On-One Headrail  | \$25.00 Net (price as one overall shade) |           |             |
| Liners - Refer to Liner Price Tables   |  |           |             |
| Edge Binding - Refer to Edge Binding Price Tables  |  |           |             |
| Shades up to 102" in width shipped via FedEx: \$ 4.00 per unit Net Freight Charge        |  |           |             |
| Shades 102-1/8" to 125" in width shipped via FedEx: \$ 75.00 per unit Net Freight Charge |  |           |             |
| Shades 125" or greater in width shipped via Common Carrier: \$ 150.00 per shipment       |  |           |             |

**Surcharge of \$ 1.50 per shade will automatically be applied to all Woven Wood Shades for Cord Shrouds.**

All prices are in U.S. dollars and do not include freight, duties or taxes for shipment to Alaska, Hawaii or Canada. GST and VAT are not included. Other restrictions and surcharges may apply. See freight policy for complete details.

**Manufacturing specifications, options, surcharges and pricing are subject to change without notice.**

Visit [www.mariak.com](http://www.mariak.com) for most recent downloads.

# Mariak

Many Window Solutions From One Source

## West Lake Woven Wood Shades Standard & Waterfall Style Shades

**Suggested Retail Price - Table C**

|               | Width           | 24                                   | 30  | 36  | 42  | 48  | 60  | 72  | 84  | 96   |
|---------------|-----------------|--------------------------------------|-----|-----|-----|-----|-----|-----|-----|------|
| <b>Length</b> | 36              | 157                                  | 181 | 204 | 217 | 243 | 301 | 351 | 429 | 494  |
|               | 48              | 177                                  | 206 | 234 | 252 | 270 | 349 | 407 | 492 | 582  |
|               | 54              | 189                                  | 220 | 251 | 272 | 292 | 369 | 446 | 536 | 614  |
|               | 60              | 201                                  | 234 | 267 | 290 | 319 | 401 | 470 | 563 | 661  |
|               | 66              | 213                                  | 248 | 282 | 307 | 342 | 433 | 510 | 609 | 708  |
|               | 72              | 224                                  | 261 | 297 | 324 | 361 | 471 | 554 | 660 | 765  |
|               | 78              | 236                                  | 275 | 314 | 349 | 392 | 499 | 586 | 698 | 810  |
|               | 84              | 247                                  | 289 | 330 | 373 | 415 | 526 | 618 | 735 | 855  |
|               | 90              | 258                                  | 302 | 346 | 391 | 435 | 562 | 659 | 781 | 908  |
|               | 96              | 269                                  | 316 | 362 | 409 | 463 | 597 | 710 | 834 | 961  |
|               | 108             | 303                                  | 356 | 407 | 460 | 521 | 672 | 799 | 938 | 1081 |
|               |                 | Roll Ease Cord Loop<br>Clutch System | 90  | 105 | 120 | 130 | 135 | 140 | 150 | 160  |
|               | Wood Bottom Bar | 13                                   | 16  | 18  | 20  | 22  | 27  | 31  | 36  | 40   |

Note: Shades measuring more than 72" in width are recommended with a continuous cord loop control.

|                |                      |                     |                   |
|----------------|----------------------|---------------------|-------------------|
| Akita Carbon   | Bamboo Forest Green  | Bamboo Palm Walnut  | Prairie Brushwood |
| Akita Hazelnut | Bamboo Palm Carbon   | Forest Grass Sage   | Sun Shade White   |
| Akita Oak      | Bamboo Palm Dark Oak | Hana Natural        | Tamarind Brown    |
| Akita Walnut   | Bamboo Palm Espresso | *Parchment Bleached |                   |

\* Wide Edge Binding Recommended

| <b>Woven Wood Surcharge Options</b>  |  |           |             |
|--|--|-----------|-------------|
| Top-Down/Bottom-Up   | \$45.00 Net                              | Arch Top  | \$60.00 Net |
| Edge Binding Fabric Valance Returns  | \$15.00 Net                              | Angle Top | \$40.00 Net |
| Custom Cord Loop Length  | \$20.00 Net                              |           |             |
| Metal Bead Chain   | \$20.00 Net                              |           |             |
| Cutouts  | \$15.00 Net Per Cutout                   |           |             |
| Two-On-One Headrail  | \$20.00 Net (price as one overall shade) |           |             |
| Three-On-One Headrail  | \$25.00 Net (price as one overall shade) |           |             |
| Liners - Refer to Liner Price Tables   |  |           |             |
| Edge Binding - Refer to Edge Binding Price Tables  |  |           |             |
| Shades up to 102" in width shipped via FedEx: \$ 4.00 per unit Net Freight Charge        |  |           |             |
| Shades 102-1/8" to 125" in width shipped via FedEx: \$ 75.00 per unit Net Freight Charge |  |           |             |
| Shades 125" or greater in width shipped via Common Carrier: \$ 150.00 per shipment       |  |           |             |

|  |
|--|
| <b>Surcharge of \$ 1.50 per shade will automatically be applied to all Woven Wood Shades for Cord Shrouds.</b>   |
| All prices are in U.S. dollars and do not include freight, duties or taxes for shipment to Alaska, Hawaii or Canada. GST and VAT are not included. Other restrictions and surcharges may apply. See freight policy for complete details. |
| Manufacturing specifications, options, surcharges and pricing are subject to change without notice.  |

Visit [www.mariak.com](http://www.mariak.com) for most recent downloads.



**West Lake Woven Wood Shades  
Standard & Waterfall Style Shades**

**Suggested Retail Price - Table D**

| Width                             | 24  | 30  | 36  | 42  | 48  | 60  | 72  | 84   | 96   |
|-----------------------------------|-----|-----|-----|-----|-----|-----|-----|------|------|
| 36                                | 188 | 216 | 243 | 260 | 276 | 351 | 409 | 497  | 586  |
| 48                                | 214 | 242 | 281 | 303 | 325 | 413 | 484 | 583  | 682  |
| 54                                | 227 | 268 | 309 | 329 | 349 | 442 | 521 | 625  | 732  |
| 60                                | 240 | 289 | 327 | 355 | 373 | 472 | 558 | 668  | 780  |
| 66                                | 254 | 301 | 347 | 372 | 397 | 539 | 620 | 730  | 850  |
| 72                                | 268 | 312 | 356 | 389 | 422 | 566 | 666 | 793  | 919  |
| 78                                | 279 | 327 | 375 | 421 | 459 | 598 | 704 | 838  | 972  |
| 84                                | 295 | 344 | 394 | 445 | 496 | 630 | 742 | 880  | 1025 |
| 90                                | 309 | 362 | 414 | 467 | 520 | 679 | 819 | 972  | 1126 |
| 96                                | 323 | 379 | 434 | 476 | 545 | 729 | 858 | 1019 | 1179 |
| 108                               | 363 | 426 | 488 | 536 | 613 | 820 | 965 | 1146 | 1326 |
| Roll Ease Cord Loop Clutch System | 90  | 105 | 120 | 130 | 135 | 140 | 150 | 160  | 170  |
| Wood Bottom Bar                   | 13  | 16  | 18  | 20  | 22  | 27  | 31  | 36   | 40   |

Note: Shades measuring more than 72" in width are recommended with a continuous cord loop control.

- |                  |                      |                         |
|------------------|----------------------|-------------------------|
| *Abaca Beige     | *Coronado White Sand | Raffia Bark             |
| *Abaca Earth     | Harmony Natural      | **St. Martin Cappuccino |
| *Abaca Red Earth | Harmony Spice        | Savanna Nightshade      |
| *Abaca Sage      | Prairie Natural      | Terra Oak               |
| Caribe Spice     | Prairie Russet       |                         |

\* Wide Edge Binding Recommended

\*\* Edge Binding Recommended

| <b>Woven Wood Surcharge Options</b>  |  |           |             |
|--|--|-----------|-------------|
| Top-Down/Bottom-Up   | \$45.00 Net                              | Arch Top  | \$60.00 Net |
| Edge Binding Fabric Valance Returns  | \$15.00 Net                              | Angle Top | \$40.00 Net |
| Custom Cord Loop Length  | \$20.00 Net                              |           |             |
| Metal Bead Chain   | \$20.00 Net                              |           |             |
| Cutouts  | \$15.00 Net Per Cutout                   |           |             |
| Two-On-One Headrail  | \$20.00 Net (price as one overall shade) |           |             |
| Three-On-One Headrail  | \$25.00 Net (price as one overall shade) |           |             |
| Liners - Refer to Liner Price Tables   |  |           |             |
| Edge Binding - Refer to Edge Binding Price Tables  |  |           |             |
| Shades up to 102" in width shipped via FedEx: \$ 4.00 per unit Net Freight Charge        |  |           |             |
| Shades 102-1/8" to 125" in width shipped via FedEx: \$ 75.00 per unit Net Freight Charge |  |           |             |
| Shades 125" or greater in width shipped via Common Carrier: \$ 150.00 per shipment       |  |           |             |

Surcharge of \$ 1.50 per shade will automatically be applied to all Woven Wood Shades for Cord Shrouds.

All prices are in U.S. dollars and do not include freight, duties or taxes for shipment to Alaska, Hawaii or Canada. GST and VAT are not included. Other restrictions and surcharges may apply. See freight policy for complete details.

Manufacturing specifications, options, surcharges and pricing are subject to change without notice.

Visit [www.mariak.com](http://www.mariak.com) for most recent downloads.



## West Lake Woven Wood Shades Additional Options for Standard, Waterfall & Twin Style Shades

Suggested Retail Price Table: Narrow Edge Bindings

| Width  |    | 24 | 30 | 36 | 42 | 48 | 60  | 72  | 84  | 96  |
|--------|----|----|----|----|----|----|-----|-----|-----|-----|
| Length | 36 | 12 | 15 | 18 | 21 | 24 | 30  | 36  | 42  | 48  |
|        | 48 | 16 | 20 | 24 | 28 | 32 | 40  | 48  | 56  | 64  |
|        | 54 | 18 | 22 | 27 | 31 | 36 | 45  | 54  | 63  | 72  |
|        | 60 | 20 | 25 | 30 | 35 | 40 | 50  | 60  | 70  | 80  |
|        | 66 | 22 | 27 | 33 | 38 | 44 | 55  | 66  | 77  | 88  |
|        | 72 | 24 | 30 | 36 | 42 | 48 | 60  | 72  | 84  | 96  |
|        | 78 | 26 | 32 | 39 | 45 | 52 | 65  | 78  | 91  | 104 |
|        | 84 | 28 | 35 | 42 | 49 | 56 | 70  | 84  | 98  | 112 |
|        | 90 | 30 | 37 | 45 | 52 | 60 | 75  | 90  | 105 | 119 |
|        | 96 | 32 | 40 | 48 | 56 | 64 | 80  | 96  | 112 | 127 |
| 108    | 36 | 45 | 54 | 63 | 71 | 90 | 108 | 125 | 144 |     |

Suggested Retail Price Table: Wide Edge Bindings

| Width  |    | 24 | 30 | 36 | 42  | 48  | 60  | 72  | 84  | 96  |
|--------|----|----|----|----|-----|-----|-----|-----|-----|-----|
| Length | 36 | 17 | 21 | 26 | 30  | 34  | 43  | 51  | 60  | 68  |
|        | 48 | 23 | 28 | 34 | 40  | 46  | 57  | 68  | 80  | 91  |
|        | 54 | 26 | 32 | 38 | 45  | 51  | 64  | 77  | 90  | 102 |
|        | 60 | 28 | 36 | 43 | 50  | 57  | 71  | 85  | 100 | 114 |
|        | 66 | 31 | 39 | 47 | 55  | 63  | 78  | 94  | 110 | 125 |
|        | 72 | 34 | 43 | 51 | 60  | 68  | 85  | 102 | 119 | 137 |
|        | 78 | 37 | 46 | 55 | 65  | 74  | 92  | 111 | 129 | 148 |
|        | 84 | 40 | 50 | 60 | 70  | 80  | 100 | 119 | 139 | 159 |
|        | 90 | 43 | 53 | 64 | 75  | 85  | 107 | 128 | 149 | 171 |
|        | 96 | 46 | 57 | 68 | 80  | 91  | 114 | 137 | 159 | 182 |
| 108    | 52 | 64 | 77 | 90 | 102 | 128 | 154 | 179 | 205 |     |

Suggested Retail Price Table: Privacy Liner

|        |    | Width |     |     |     |     |     |     |     |     |
|--------|----|-------|-----|-----|-----|-----|-----|-----|-----|-----|
|        |    | 24    | 30  | 36  | 42  | 48  | 60  | 72  | 84  | 96  |
| Length | 36 | 28    | 35  | 42  | 49  | 56  | 70  | 84  | 98  | 112 |
|        | 48 | 37    | 47  | 56  | 65  | 75  | 93  | 112 | 131 | 149 |
|        | 54 | 42    | 53  | 63  | 74  | 84  | 105 | 126 | 147 | 168 |
|        | 60 | 47    | 58  | 70  | 82  | 93  | 117 | 140 | 163 | 187 |
|        | 66 | 51    | 64  | 77  | 90  | 103 | 128 | 154 | 180 | 205 |
|        | 72 | 56    | 70  | 84  | 98  | 112 | 140 | 168 | 196 | 224 |
|        | 78 | 61    | 76  | 91  | 106 | 121 | 152 | 182 | 212 | 243 |
|        | 84 | 65    | 82  | 98  | 114 | 131 | 163 | 196 | 229 | 261 |
|        | 90 | 70    | 88  | 105 | 123 | 140 | 175 | 210 | 245 | 280 |
|        | 96 | 75    | 93  | 112 | 131 | 149 | 187 | 224 | 261 | 299 |
| 108    | 84 | 105   | 126 | 147 | 168 | 210 | 252 | 294 | 336 |     |

All prices are in U.S. dollars and do not include freight, duties or taxes for shipment to Alaska, Hawaii or Canada. GST and VAT are not included. Other restrictions and surcharges may apply. See freight policy for complete details.

Manufacturing specifications, options, surcharges and pricing are subject to change without notice.

Visit [www.mariak.com](http://www.mariak.com) for most recent downloads.

**Suggested Retail Price Table: Black-Out Liner**

|        |     |     |     |     |     |     |     |     |     |
|--------|-----|-----|-----|-----|-----|-----|-----|-----|-----|
| Width  | 24  | 30  | 36  | 42  | 48  | 60  | 72  | 84  | 96  |
| Length | 36  | 45  | 54  | 63  | 72  | 90  | 108 | 126 | 144 |
| 48     | 48  | 60  | 72  | 84  | 96  | 120 | 144 | 168 | 192 |
| 54     | 54  | 68  | 81  | 95  | 108 | 135 | 162 | 189 | 216 |
| 60     | 60  | 75  | 90  | 105 | 120 | 150 | 180 | 210 | 240 |
| 66     | 66  | 83  | 99  | 116 | 132 | 165 | 198 | 231 | 264 |
| 72     | 72  | 90  | 108 | 126 | 144 | 180 | 216 | 252 | 288 |
| 78     | 78  | 98  | 117 | 137 | 156 | 195 | 234 | 273 | 312 |
| 84     | 84  | 105 | 126 | 147 | 168 | 210 | 252 | 294 | 336 |
| 90     | 90  | 113 | 135 | 158 | 180 | 225 | 270 | 315 | 360 |
| 96     | 96  | 120 | 144 | 168 | 192 | 240 | 288 | 336 | 384 |
| 108    | 108 | 135 | 162 | 189 | 216 | 270 | 324 | 378 | 432 |

**Suggested Retail Price Table: Optional Valance Liner (Privacy Beige Only)**

|       |    |    |    |    |    |    |    |    |    |
|-------|----|----|----|----|----|----|----|----|----|
| Width | 24 | 30 | 36 | 42 | 48 | 60 | 72 | 84 | 96 |
|       | 5  | 6  | 6  | 7  | 7  | 9  | 10 | 11 | 12 |

**Suggested Retail Price Table: Valance Only - 6" Drop/Length**

|                     |   |    |     |     |     |     |     |
|---------------------|---|----|-----|-----|-----|-----|-----|
| Width               | 24  | 36 | 48  | 60  | 72  | 84  | 96  |
| Group A             | Baja Sand, Driftwood Natural, Fiji Natural, Kyoto Brown, Kyoto Merlot, Laguna Umber, Latice Twilight, Mandalay Oak, Mandalay Pistachio, Medan Carmel, Monterey Oak, Panama Cedar, Penang Oak, Rustic Pecan, Tustic Tan, Tiki Carbon                                     |    |     |     |     |     |     |
| Retail Cost         | 38  | 52 | 63  | 82  | 93  | 105 | 118 |
| Per Extra Inch Add: | 6   | 8  | 10  | 13  | 15  | 17  | 19  |
| Group B             | Aspen Walnut, Bamboo Reeds Wheat, Bamboo Weave Camel, Bora Bora Natural, Camana Pecan, Cabana Saddle, Kowloon Bay, Nocturne Ebony, Sumatra Espresso, Sumatra Saddle, Sun Shade Brown, Sun Shade Natural, Westport Nutmeg  |    |     |     |     |     |     |
| Retail Cost         | 47  | 65 | 79  | 102 | 116 | 132 | 147 |
| Per Extra Inch Add: | 8   | 10 | 13  | 16  | 19  | 21  | 24  |
| Group C             | Akita Carbon, Akita Hazelnut, Akita Oak, Akita Walnut, Bamboo Forest Green, Bamboo Palm Carbon, Bamboo Palm Dark Oak, Bamboo Palm Espresso, Bamboo Palm Walnut, Forest Grass Sage, Hana Natural, Parchment Bleached, Prairie Brushwood, Sun Shade White, Tamarind Brown |    |     |     |     |     |     |
| Retail Cost         | 51  | 70 | 85  | 109 | 124 | 141 | 157 |
| Per Extra Inch Add: | 8   | 11 | 14  | 18  | 20  | 23  | 25  |
| Group D             | Abaca Beige, Abaca Earth, Abaca Red Earth, Abaca Sage, Caribe Spice, Coronado White Sand, Harmony Natural, harmony Spice, Prairie Natural, Prairie Russet, Raffia Bark, Savanna Nighshade, St. martin Cappuccino, Terra Oak   |    |     |     |     |     |     |
| Retail Cost         | 62  | 85 | 103 | 134 | 152 | 172 | 192 |
| Per Extra Inch Add: | 10  | 14 | 17  | 21  | 24  | 28  | 31  |

**Valance Only Liner Options: +30% Privacy Liner +40% Blackout Liner**

**Valance Only:** Inside Mount a deduction of 3/8" will be made to the width  
 No deductions will be taken for Outside Mount  
 Outside Mount valance will be supplied with returns  
 Valance only orders come standard on a 1-1/2" headrail  
 Valances are 6" long standard and are stapled to the front of the headrail

Maximum valance width 96"  
 Maximum Length 24"

All prices are in U.S. dollars and do not include freight, duties or taxes for shipment to Alaska, Hawaii or Canada. GST and VAT are not included. Other restrictions and surcharges may apply. See freight policy for complete details.

Manufacturing specifications, options, surcharges and pricing are subject to change without notice.

Visit [www.mariak.com](http://www.mariak.com) for most recent downloads.

## West Lake Woven Wood Shades - Twin Shade with Privacy Liner

**Suggested Retail Price Table: Twin Shade with Privacy Liner - Group A Patterns**

| Length                            | Width | 24           | 30  | 36                 | 42  | 48           | 60  | 72           | 84    | 96  |
|-----------------------------------|-------|--------------|-----|--------------------|-----|--------------|-----|--------------|-------|-----|
|                                   | 36    | 160          | 186 | 213                | 239 | 279          | 339 | 412          | 466   | 519 |
| 48                                | 173   | 200          | 226 | 266                | 306 | 372          | 440 | 519          | 559   |     |
| 54                                | 186   | 213          | 247 | 293                | 346 | 419          | 495 | 577          | 660   |     |
| 60                                | 200   | 229          | 275 | 321                | 379 | 452          | 550 | 641          | 733   |     |
| 66                                | 213   | 252          | 302 | 353                | 403 | 499          | 605 | 705          | 806   |     |
| 72                                | 226   | 275          | 330 | 385                | 440 | 550          | 660 | 769          | 879   |     |
| 78                                | 239   | 298          | 357 | 417                | 476 | 595          | 715 | 834          | 953   |     |
| 84                                | 259   | 321          | 385 | 449                | 513 | 632          | 769 | 898          | 1,026 |     |
| 90                                | 273   | 339          | 412 | 481                | 539 | 678          | 824 | 962          | 1,099 |     |
| 96                                | 293   | 359          | 439 | 513                | 559 | 705          | 879 | 1,037        | 1,197 |     |
| 108                               | 330   | 403          | 494 | 577                | 629 | 793          | 989 | 1,167        | 1,347 |     |
| Roll Ease Cord Loop Clutch System |       | 90           | 105 | 120                | 130 | 135          | 140 | 150          | 160   | 170 |
| Wood Bottom Bar                   |       | 13           | 16  | 18                 | 20  | 22           | 27  | 31           | 36    | 40  |
| Baja Sand                         |       | Kyoto Brown  |     | Lattice Twilight   |     | Medan Camel  |     | Penang Oak   |       |     |
| Driftwood Natural                 |       | Kyoto Merlot |     | Mandalay Oak       |     | Monterey Oak |     | Rustic Pecan |       |     |
| Fiji Natural                      |       | Laguna Umber |     | Mandalay Pistachio |     | Panama Cedar |     | Rustic Tan   |       |     |
|                                   |       |              |     |                    |     |              |     | Tiki Carbon  |       |     |

**Suggested Retail Price Table: Twin Shade with Privacy Liner - Group B Patterns**

| Length                            | Width | 24                         | 30  | 36  | 42               | 48  | 60    | 72                | 84    | 96  |
|-----------------------------------|-------|----------------------------|-----|-----|------------------|-----|-------|-------------------|-------|-----|
|                                   | 36    | 179                        | 227 | 268 | 316              | 358 | 447   | 537               | 632   | 710 |
| 48                                | 197   | 245                        | 286 | 340 | 382              | 471 | 561   | 668               | 752   |     |
| 54                                | 233   | 268                        | 310 | 364 | 400              | 495 | 591   | 698               | 800   |     |
| 60                                | 257   | 286                        | 334 | 382 | 436              | 519 | 621   | 734               | 841   |     |
| 66                                | 274   | 310                        | 358 | 406 | 459              | 550 | 668   | 782               | 895   |     |
| 72                                | 292   | 328                        | 382 | 430 | 483              | 600 | 728   | 847               | 960   |     |
| 78                                | 310   | 346                        | 400 | 455 | 520              | 650 | 780   | 910               | 1,040 |     |
| 84                                | 328   | 364                        | 424 | 490 | 560              | 700 | 847   | 980               | 1,120 |     |
| 90                                | 346   | 382                        | 450 | 525 | 600              | 750 | 900   | 1,050             | 1,200 |     |
| 96                                | 364   | 406                        | 480 | 560 | 640              | 800 | 960   | 1,120             | 1,280 |     |
| 108                               | 410   | 457                        | 540 | 630 | 720              | 900 | 1,080 | 1,260             | 1,440 |     |
| Roll Ease Cord Loop Clutch System |       | 90                         | 105 | 120 | 130              | 135 | 140   | 150               | 160   | 170 |
| Wood Bottom Bar                   |       | 13                         | 16  | 18  | 20               | 22  | 27    | 31                | 36    | 40  |
| Aspen Walnut                      |       | *Bora Bora Natural         |     |     | Kowloon Bay      |     |       | Sumatra Saddle    |       |     |
| Bamboo Reeds Wheat                |       | Cabana Pecan               |     |     | Noctune Ebony    |     |       | Sun Shade Brown   |       |     |
| Bamboo Weave Camel                |       | Cabana Saddle              |     |     | Sumatra Espresso |     |       | Sun Shade Natural |       |     |
|                                   |       | * Edge Binding Recommended |     |     |                  |     |       | Westport Nutmeg   |       |     |

### Woven Wood Surcharge Options

|   |  |
|---|--|
| Two-On-One Headrail   | \$20.00 Net (price as one overall shade) |
| Three-On-One Headrail   | \$25.00 Net (price as one overall shade) |
| Cord Loop is available for both Front & Back  | Add Cord Loop Surcharge Twice            |
| Shades up to 102" in width shipped via FedEx: \$ 4.00 per unit Net Freight Charge   |  |
| Shades 102-1/8" to 125" in width shipped via FedEx: \$ 75.00 per unit Net Freight Charge  |  |
| Shades 125" or greater in width shipped via Common Carrier: \$ 150.00 per shipment  |  |
| <b>Surcharge of \$ 1.50 per shade will automatically be applied to all Woven Wood Shades for Cord Shrouds.</b>  |  |
| All prices are in U.S. Dollars and do not include freight, duties or taxes for shipments to Alasta, Hawaii or Canada. GST and VAT are not included. Other restrictions and surcharges may apply. See Freight Policy for complete details. |  |
| Manufacturing specifications, options, surcharges and pricing are subject to change without notice.   |  |

Visit [www.mariak.com](http://www.mariak.com) for most recent dowloads.

## West Lake Woven Wood Shades - Twin Shade with Privacy Liner

**Suggested Retail Price Table: Twin Shade with Privacy Liner - Group C Patterns**

| Length | Width                             | 24  | 30  | 36  | 42  | 48    | 60    | 72    | 84    | 96  |
|--------|-----------------------------------|-----|-----|-----|-----|-------|-------|-------|-------|-----|
|        | 36                                | 219 | 265 | 302 | 347 | 389   | 539   | 662   | 810   | 920 |
| 48     | 232                               | 275 | 312 | 351 | 400 | 542   | 687   | 829   | 935   |     |
| 54     | 248                               | 285 | 330 | 379 | 410 | 557   | 710   | 848   | 963   |     |
| 60     | 278                               | 307 | 357 | 400 | 458 | 590   | 729   | 871   | 1,020 |     |
| 66     | 298                               | 333 | 381 | 424 | 486 | 631   | 793   | 939   | 1,094 |     |
| 72     | 318                               | 352 | 405 | 448 | 510 | 707   | 877   | 1,039 | 1,200 |     |
| 78     | 341                               | 373 | 426 | 482 | 563 | 763   | 934   | 1,114 | 1,300 |     |
| 84     | 362                               | 394 | 452 | 530 | 610 | 817   | 1,012 | 1,199 | 1,402 |     |
| 90     | 380                               | 412 | 480 | 567 | 652 | 869   | 1,059 | 1,265 | 1,486 |     |
| 96     | 400                               | 439 | 514 | 604 | 707 | 917   | 1,132 | 1,345 | 1,570 |     |
| 108    | 450                               | 495 | 578 | 680 | 796 | 1,034 | 1,275 | 1,513 | 1,769 |     |
|        | Roll Ease Cord Loop Clutch System | 90  | 105 | 120 | 130 | 135   | 140   | 150   | 160   | 170 |
|        | Wood Bottom Bar                   | 13  | 16  | 18  | 20  | 22    | 27    | 31    | 36    | 40  |

|                |                      |                     |                   |
|----------------|----------------------|---------------------|-------------------|
| Akita Carbon   | Bamboo Forest Green  | Bamboo Palm Walnut  | Prairie Brushwood |
| Akita Hazelnut | Bamboo Palm Carbon   | Forest Grass Sage   | Sun Shade White   |
| Akita Oak      | Bamboo Palm Dark Oak | Hana Natural        | Tamarind Brown    |
| Akita Walnut   | Bamboo Palm Espresso | *Parchment Bleached |                   |

\* Edge Binding Recommended

**Suggested Retail Price Table: Twin Shade with Privacy Liner - Group D Patterns**

| Length | Width                             | 24  | 30  | 36  | 42  | 48    | 60    | 72    | 84    | 96    |
|--------|-----------------------------------|-----|-----|-----|-----|-------|-------|-------|-------|-------|
|        | 36                                | 263 | 316 | 359 | 415 | 460   | 629   | 772   | 938   | 1,042 |
| 48     | 281                               | 331 | 364 | 432 | 478 | 642   | 793   | 959   | 1,098 |       |
| 54     | 298                               | 348 | 406 | 459 | 490 | 667   | 830   | 989   | 1,148 |       |
| 60     | 332                               | 380 | 437 | 489 | 536 | 694   | 866   | 1,033 | 1,204 |       |
| 66     | 356                               | 404 | 469 | 513 | 565 | 786   | 964   | 1,125 | 1,314 |       |
| 72     | 381                               | 421 | 485 | 537 | 596 | 849   | 1,054 | 1,247 | 1,440 |       |
| 78     | 403                               | 444 | 508 | 632 | 659 | 914   | 1,123 | 1,337 | 1,559 |       |
| 84     | 434                               | 469 | 541 | 651 | 728 | 979   | 1,215 | 1,435 | 1,681 |       |
| 90     | 455                               | 494 | 575 | 677 | 780 | 1,050 | 1,316 | 1,575 | 1,842 |       |
| 96     | 481                               | 527 | 616 | 703 | 832 | 1,121 | 1,368 | 1,643 | 1,927 |       |
| 108    | 539                               | 592 | 693 | 793 | 937 | 1,262 | 1,539 | 1,849 | 2,170 |       |
|        | Roll Ease Cord Loop Clutch System | 90  | 105 | 120 | 130 | 135   | 140   | 150   | 160   | 170   |
|        | Wood Bottom Bar                   | 13  | 16  | 18  | 20  | 22    | 27    | 31    | 36    | 40    |

|                  |                     |                 |                         |
|------------------|---------------------|-----------------|-------------------------|
| *Abaca Beige     | *Abaca Sage         | Harmony Natural | Raffia Bark             |
| *Abaca Earth     | Caribe Spice        | Harmony Spice   | **St. Martin Cappuccino |
| *Abaca Red Earth | Coronado White Sand | Prairie Natural | Savanna Nightshade      |
|                  |                     | Prairie Russet  | Terra Oak               |

\* Wide Edge Binding Recommended

\*\* Edge Binding Recommended

### Woven Wood Surcharge Options

|   |  |
|---|--|
| Two-On-One Headrail   | \$20.00 Net (price as one overall shade) |
| Three-On-One Headrail   | \$25.00 Net (price as one overall shade) |
| Cord Loop is available for both Front & Back  | Add Cord Loop Surcharge Twice            |
| Shades up to 102" in width shipped via FedEx:   | \$ 4.00 per unit Net Freight Charge      |
| Shades 102-1/8" to 125" in width shipped via FedEx:   | \$ 75.00 per unit Net Freight Charge     |
| Shades 125" or greater in width shipped via Common Carrier:   | \$ 150.00 per shipment                   |
| <b>Surcharge of \$ 1.50 per shade will automatically be applied to all Woven Wood Shades for Cord Shrouds.</b>  |  |
| All prices are in U.S. Dollars and do not include freight, duties or taxes for shipments to Alaska, Hawaii or Canada. GST and VAT are not included. Other restrictions and surcharges may apply. See Freight Policy for complete details. |  |
| Manufacturing specifications, options, surcharges and pricing are subject to change without notice.   |  |

Visit [www.mariak.com](http://www.mariak.com) for the most recent downloads.



## West Lake Woven Wood Shades - Twin Shade with Black-Out Liner

**Suggested Retail Price Table: Twin Shade with Black-Out Liner - Group C Patterns**

| Length | Width                             | 24  | 30  | 36  | 42  | 48    | 60    | 72    | 84    | 96  |
|--------|-----------------------------------|-----|-----|-----|-----|-------|-------|-------|-------|-----|
| 36     | 237                               | 286 | 306 | 347 | 419 | 568   | 705   | 849   | 994   |     |
| 48     | 251                               | 298 | 326 | 379 | 429 | 585   | 720   | 874   | 1,006 |     |
| 54     | 268                               | 308 | 356 | 410 | 442 | 602   | 767   | 916   | 1,040 |     |
| 60     | 300                               | 332 | 385 | 432 | 495 | 637   | 787   | 940   | 1,102 |     |
| 66     | 322                               | 360 | 411 | 458 | 525 | 682   | 856   | 1,014 | 1,182 |     |
| 72     | 344                               | 381 | 437 | 483 | 550 | 763   | 948   | 1,122 | 1,296 |     |
| 78     | 368                               | 403 | 460 | 521 | 608 | 824   | 1,009 | 1,203 | 1,404 |     |
| 84     | 391                               | 425 | 489 | 572 | 658 | 883   | 1,093 | 1,295 | 1,514 |     |
| 90     | 410                               | 445 | 519 | 612 | 704 | 938   | 1,143 | 1,366 | 1,605 |     |
| 96     | 432                               | 474 | 555 | 652 | 764 | 990   | 1,223 | 1,453 | 1,696 |     |
| 108    | 485                               | 533 | 624 | 734 | 859 | 1,117 | 1,376 | 1,633 | 1,910 |     |
|        | Roll Ease Cord Loop Clutch System | 90  | 105 | 120 | 130 | 135   | 140   | 150   | 160   | 170 |
|        | Wood Bottom Bar                   | 13  | 16  | 18  | 20  | 22    | 27    | 31    | 36    | 40  |

|                |                     |                      |                     |                   |
|----------------|---------------------|----------------------|---------------------|-------------------|
| Akita Carbon   | Akita Walnut        | Bamboo Palm Dark Oak | Forest Grass Sage   | Prairie Brushwood |
| Akita Hazelnut | Bamboo Forest Green | Bamboo Palm Espresso | Hana Natural        | Sun Shade White   |
| Akita Oak      | Bamboo Palm Carbon  | Bamboo Palm Walnut   | *Parchment Bleached | Tamarind Brown    |

\*Edge Binding Recommended

**Suggested Retail Price Table: Twin Shade with Black-Out Liner - Group D Patterns**

| Length | Width                             | 24  | 30  | 36  | 42    | 48    | 60    | 72    | 84    | 96  |
|--------|-----------------------------------|-----|-----|-----|-------|-------|-------|-------|-------|-----|
| 36     | 284                               | 341 | 371 | 448 | 497   | 676   | 834   | 1,014 | 1,079 |     |
| 48     | 303                               | 356 | 398 | 456 | 504   | 693   | 856   | 1,035 | 1,167 |     |
| 54     | 322                               | 375 | 439 | 495 | 529   | 721   | 896   | 1,068 | 1,239 |     |
| 60     | 358                               | 410 | 472 | 529 | 579   | 770   | 935   | 1,116 | 1,300 |     |
| 66     | 384                               | 437 | 506 | 554 | 610   | 849   | 1,041 | 1,215 | 1,419 |     |
| 72     | 411                               | 455 | 524 | 580 | 643   | 916   | 1,138 | 1,347 | 1,556 |     |
| 78     | 435                               | 479 | 549 | 604 | 712   | 987   | 1,212 | 1,444 | 1,684 |     |
| 84     | 468                               | 506 | 584 | 682 | 787   | 1,057 | 1,312 | 1,550 | 1,816 |     |
| 90     | 491                               | 533 | 621 | 731 | 842   | 1,134 | 1,421 | 1,701 | 1,989 |     |
| 96     | 519                               | 569 | 665 | 759 | 899   | 1,211 | 1,478 | 1,775 | 2,081 |     |
| 108    | 581                               | 638 | 749 | 856 | 1,011 | 1,362 | 1,662 | 1,996 | 2,343 |     |
|        | Roll Ease Cord Loop Clutch System | 90  | 105 | 120 | 130   | 135   | 140   | 150   | 160   | 170 |
|        | Wood Bottom Bar                   | 13  | 16  | 18  | 20    | 22    | 27    | 31    | 36    | 40  |

|                  |                     |                 |                         |                    |
|------------------|---------------------|-----------------|-------------------------|--------------------|
| *Abaca Beige     | *Abaca Sage         | Harmony Natural | Prairie Russet          | Savanna Nightshade |
| *Abaca Earth     | Caribe Spice        | Harmony Spice   | Raffia Bark             | Terra Oak          |
| *Abaca Red Earth | Coronado White Sand | Prairie Natural | **St. Martin Cappuccino |                    |

\* Wide Edge Binding Recommended      \*\*Edge Binding Recommended

| <b>Woven Wood Surcharge Options</b>   |                                      |
|---|--------------------------------------|
| Two-On-One Headrail   | \$20.00 (price as one overall shade) |
| Three-On-One Headrail   | \$25.00 (price as one overall shade) |
| Cord Loop is available for both Front & Back  | Add Cord Loop Surcharge Twice        |
| Shades up to 102" in width shipped via FedEx: \$ 4.00 per unit Net Freight Charge   |                                      |
| Shades 102-1/8" to 125" in width shipped via FedEx: \$ 75.00 per unit Net Freight Charge  |                                      |
| Shades 125" or greater in width shipped via Common Carrier: \$ 150.00 per shipment  |                                      |
| <b>Surcharge of \$ 1.50 per shade will automatically be applied to all Woven Wood Shades for Cord Shrouds.</b>  |                                      |
| All prices are in U.S. Dollars and do not include freight, duties or taxes for shipments to Alasta, Hawaii or Canada. GST and VAT are not included. Other restrictions and surcharges may apply. See Freight Policy for complete details. |                                      |
| Manufacturing specifications, options, surcharges and pricing are subject to change without notice.   |                                      |

Visit [www.mariak.com](http://www.mariak.com) for the most recent downloads.

## West Lake Woven Wood Shades Folding Door Shades

**Suggested Retail Price Table A**

|            | Width |     |     |     |     |     |               |
|------------|-------|-----|-----|-----|-----|-----|---------------|
|            | 48    | 60  | 72  | 84  | 96  | 120 | Per Extra 12" |
| 48         | 236   | 278 | 318 | 368 | 417 | 510 | 47            |
| 60         | 263   | 311 | 357 | 413 | 468 | 574 | 53            |
| 72         | 290   | 344 | 396 | 458 | 519 | 638 | 59            |
| 84         | 317   | 377 | 436 | 503 | 570 | 702 | 66            |
| 96         | 345   | 411 | 475 | 548 | 621 | 766 | 73            |
| Valance 8" | 71    | 73  | 93  | 95  | 117 | 146 | 10            |

Note: One-way folding door prices listed above.

|                   |                    |              |                       |
|-------------------|--------------------|--------------|-----------------------|
| Baja Sand         | Kyoto Merlot       | Monterey Oak | Rustic Tan            |
| Driftwood Natural | Lattice Twilight   | Panama Cedar | St. Martin Cappuccino |
| Fiji Natural      | Mandalay Oak       | Penang Oak   | Tiki Carbon           |
| Kyoto Brown       | Mandalay Pistachio | Rustic Pecan |                       |

**Suggested Retail Price Table B**

|            | Width |     |     |     |     |     |               |
|------------|-------|-----|-----|-----|-----|-----|---------------|
|            | 48    | 60  | 72  | 84  | 96  | 120 | Per Extra 12" |
| 48         | 251   | 297 | 341 | 394 | 447 | 547 | 50            |
| 60         | 282   | 335 | 385 | 446 | 505 | 621 | 58            |
| 72         | 313   | 372 | 430 | 497 | 564 | 694 | 65            |
| 84         | 344   | 410 | 475 | 549 | 623 | 767 | 72            |
| 96         | 375   | 448 | 520 | 601 | 681 | 841 | 80            |
| Valance 8" | 78    | 82  | 103 | 106 | 132 | 165 | 12            |

Note: One-way folding door prices listed above.

|                   |               |                   |
|-------------------|---------------|-------------------|
| Aspen Walnut      | Cabana Saddle | Nocturne Ebony    |
| Bora Bora Natural | Kowloon Bay   | Sun Shade Brown   |
| Cabana Pecan      |               | Sun Shade Natural |

| Folding Door Woven Wood Surcharge Options   |                                  |
|---|----------------------------------|
| Split Draw (Center Opening)   | \$99.00 Net                      |
| 5% Fullness   | 5% is Standard (No Extra Charge) |
| 20% Fullness  | Add 20%                          |
| Privacy Liner   | Add 30%                          |
| Black Out Liner   | Add 40%                          |
| Handling Fees:  | \$20.00 Net per shade up to 96"  |
|   | \$50.00 Net per shade over 96"   |
| Shades up to 102" in width shipped via FedEx: \$ 4.00 per unit Net Freight Charge   |                                  |
| Shades 102-1/8" to 125" in width shipped via FedEx: \$ 75.00 per unit Net Freight Charge  |                                  |
| Shades 125" or greater in width shipped via Common Carrier: \$ 150.00 per shipment  |                                  |
| All prices are in U.S. Dollars and do not include freight, duties or taxes for shipments to Alasta, Hawaii or Canada. GST and VAT are not included. Other restrictions and surcharges may apply. See Freight Policy for complete details. |                                  |
| Manufacturing specifications, options, surcharges and pricing are subject to change without notice.   |                                  |

Visit [www.mariak.com](http://www.mariak.com) for the most recent downloads.



## West Lake Woven Wood Shades Folding Door Shades

**Suggested Retail Price Table C**

|            | Width |     |     |     |     |     |               |
|------------|-------|-----|-----|-----|-----|-----|---------------|
|            | 48    | 60  | 72  | 84  | 96  | 120 | Per Extra 12" |
| 48         | 277   | 329 | 379 | 439 | 498 | 612 | 55            |
| 60         | 314   | 375 | 434 | 502 | 570 | 701 | 65            |
| 72         | 351   | 421 | 488 | 565 | 641 | 791 | 75            |
| 84         | 389   | 467 | 543 | 628 | 713 | 880 | 83            |
| 96         | 426   | 513 | 597 | 691 | 784 | 970 | 93            |
| Valance 8" | 91    | 96  | 120 | 125 | 155 | 184 | 14            |

Note: One-way folding door prices listed above.

|                |                     |                      |                   |
|----------------|---------------------|----------------------|-------------------|
| Akita Carbon   | Akita Walnut        | Bamboo Palm Dark Oak | Forest Grass Sage |
| Akita Hazelnut | Bamboo Forest Green | Bamboo Palm Espresso | Hana Natural      |
| Akita Oak      | Bamboo Palm Carbon  | Bamboo Palm Walnut   | Tamarind Brown    |

**Suggested Retail Price Table D**

|            | Width |     |     |     |     |       |               |
|------------|-------|-----|-----|-----|-----|-------|---------------|
|            | 48    | 60  | 72  | 84  | 96  | 120   | Per Extra 12" |
| 48         | 296   | 354 | 409 | 474 | 538 | 662   | 62            |
| 60         | 339   | 406 | 471 | 546 | 620 | 764   | 72            |
| 72         | 381   | 458 | 533 | 617 | 701 | 865   | 82            |
| 84         | 424   | 510 | 595 | 689 | 783 | 967   | 92            |
| 96         | 466   | 562 | 657 | 761 | 864 | 1,069 | 102           |
| Valance 8" | 101   | 108 | 133 | 140 | 174 | 218   | 16            |

Note: One-way folding door prices listed above.

|             |                       |           |
|-------------|-----------------------|-----------|
| Abaca Earth | St. Martin Cappucinno | Terra Oak |
|-------------|-----------------------|-----------|

| <b>Folding Door Woven Wood Surcharge Options</b>  |                                  |
|---|----------------------------------|
| Split Draw (Center Opening)   | \$99.00 Net                      |
| 5% Fullness   | 5% is Standard (No Extra Charge) |
| 20% Fullness  | Add 20%                          |
| Privacy Liner   | Add 30%                          |
| Black Out Liner   | Add 40%                          |
| Handling Fees:  | \$20.00 Net per shade up to 96"  |
|   | \$50.00 Net per shade over 96"   |
| Shades up to 102" in width shipped via FedEx: \$ 4.00 per unit Net Freight Charge   |                                  |
| Shades 102-1/8" to 125" in width shipped via FedEx: \$ 75.00 per unit Net Freight Charge  |                                  |
| Shades 125" or greater in width shipped via Common Carrier: \$ 150.00 per shipment  |                                  |
| All prices are in U.S. Dollars and do not include freight, duties or taxes for shipments to Alasta, Hawaii or Canada. GST and VAT are not included. Other restrictions and surcharges may apply. See Freight Policy for complete details. |                                  |
| Manufacturing specifications, options, surcharges and pricing are subject to change without notice.   |                                  |

Visit [www.mariak.com](http://www.mariak.com) for the most recent downloads.



# Mariak

Many Window Solutions From One Source

575 West Manville Street, Rancho Dominguez, CA 90220  
 Customer Service Fax: (800) 459-6999 / International Fax: (310) 763-1749  
 PH: (800) 562-7425 / (310) 661-4400

## Purchase Order Woven Wood Shades

Account #: \_\_\_\_\_ Company Name: \_\_\_\_\_ Contact: \_\_\_\_\_ Purchase Order #: \_\_\_\_\_  
 Ship To Address: \_\_\_\_\_ Phone: \_\_\_\_\_ Sidemark: \_\_\_\_\_  
 City: \_\_\_\_\_ State: \_\_\_\_\_ Zip: \_\_\_\_\_ Fax: \_\_\_\_\_ Date Required: \_\_\_\_\_  
 EMAIL: \_\_\_\_\_

Ship Via (circle one): FedEX Common Carrier Mariak Truck Will Call

| Line | Sidemark | Qty | Mount <sup>1</sup> | Width | Length | Shade Type <sup>2</sup> | Pattern <sup>3</sup> | Color <sup>4</sup> | Lift Type <sup>5</sup> | Lift Side <sup>6</sup> | Liner <sup>7</sup> | Edge Binding <sup>8</sup> | Hold Downs | Wood Bottom Bar <sup>9</sup> | Spacer Block |
|------|----------|-----|--------------------|-------|--------|-------------------------|----------------------|--------------------|------------------------|------------------------|--------------------|---------------------------|------------|------------------------------|--------------|
| 1    |          |     |                    |       |        |                         |                      |                    |                        |                        |                    |                           |            |                              |              |
| 2    |          |     |                    |       |        |                         |                      |                    |                        |                        |                    |                           |            |                              |              |
| 3    |          |     |                    |       |        |                         |                      |                    |                        |                        |                    |                           |            |                              |              |
| 4    |          |     |                    |       |        |                         |                      |                    |                        |                        |                    |                           |            |                              |              |
| 5    |          |     |                    |       |        |                         |                      |                    |                        |                        |                    |                           |            |                              |              |
| 6    |          |     |                    |       |        |                         |                      |                    |                        |                        |                    |                           |            |                              |              |
| 7    |          |     |                    |       |        |                         |                      |                    |                        |                        |                    |                           |            |                              |              |
| 8    |          |     |                    |       |        |                         |                      |                    |                        |                        |                    |                           |            |                              |              |
| 9    |          |     |                    |       |        |                         |                      |                    |                        |                        |                    |                           |            |                              |              |
| 10   |          |     |                    |       |        |                         |                      |                    |                        |                        |                    |                           |            |                              |              |

**Purchase Order Footnotes:**

|   |  |   |
|---|--|---|
| <b>1. Mount:</b><br>(IM) - Inside Mount<br>(OM) - Outside Mount   | <b>3. Pattern:</b><br>Specify the fabric pattern name.                               | <b>7. Liner:</b><br>(None)<br>(PL-FL4) - Privacy Liner FL4 Natural<br>(PL-FL8) - Privacy Liner FL8 Beige<br>(PL-FL5) - Privacy Liner FL5 Cocoa<br>(PL-FL7) - Privacy Liner FL7 White<br>(BO-FL9) - Black Out Liner FL9 Soft White<br>(BO-FL2) - Black Out Liner FL2 Beige |
| <b>2. Shade Type:</b><br>(STND) - Standard Style Shade<br>(WTF) - Waterfall Style Shade<br>(TWN - STND) - Twin Fold with Standard Style Front Shade<br>(TWN - WTF) - Twin Fold with Waterfall Style Front Shade<br>(TDBU) - Top-Down / Bottom-Up Shade<br>(ARCH) - Standard Style Shade with Arch Top Valance<br>(ANGL) - Angled Top Style Shade<br>(ZON1) - Two on One Headrail                                      | <b>4. Color:</b><br>Specify the color number and name.                               | <b>Valance liners are available for an additional surcharge.</b>  |
| <b>5. Lift Type:</b><br>(PC) - Standard Pull Cord (Cord Lock Mechanism)<br>(CCL) - Continuous Cord Loop (Clutch Mechanism)<br>(MTR-BAT) - Motorized (Powered by Somfy Battery LT30 RTS)<br>(MTR-DC-RTS) - Motorized (Powered by Low Voltage Somfy Sonese 30 RTS)<br>(MTR-AC-RTS) - Motorized (Powered by High Voltage Somfy Sonese 50 RTS)<br>(MTR-AC-HW) - Motorized (Powered by High Voltage standard 4-wire motor) | <b>6. Lift Cord Control:</b><br>(R) - Right Side Lift Cord (L) - Left Side Lift Cord |   |
| <b>8. Edge Binding:</b><br>If desired, specify edge binding color & Narrow or Wide.   |  | <b>9. Wood Bar:</b><br>If desired, specify the wood bottom bar color.   |

Note: For Twin Style Shades, please note if you want both Pull Cord for the Shade and Liner, Cord Loop for the Shade and Pull Cord for the Liner or Cord Loop for both the Shade and the Liner.  
 Note: All Twin Shades include Privacy or Black-Out Liner. Please specify one when ordering.



575 West Manville Street, Rancho Dominguez, CA 90220  
 Customer Service Fax: (800) 459-6999 / International Fax: (310) 763-1749  
 PH: (800) 562-7425 / (310) 661-4400

## Purchase Order Woven Wood Folding Door Shades

Account #: \_\_\_\_\_ Company Name: \_\_\_\_\_ Contact: \_\_\_\_\_ Purchase Order #: \_\_\_\_\_

Ship To Address: \_\_\_\_\_ Phone: \_\_\_\_\_ Sidemark: \_\_\_\_\_

City: \_\_\_\_\_ State: \_\_\_\_\_ Zip: \_\_\_\_\_ Fax: \_\_\_\_\_ Date Required: \_\_\_\_\_

EMAIL: \_\_\_\_\_ Ship Via (circle one):  FedEX  Common Carrier  Mariak Truck  Will Call

| Line | Sidemark | Qty | Mount <sup>1</sup> | Width | Length | Shade Type   | Pattern <sup>2</sup> | Color <sup>3</sup> | Stack Type <sup>5</sup> | Fullness <sup>6</sup> | Liner <sup>7</sup> | Valance <sup>8</sup> |
|------|----------|-----|--------------------|-------|--------|--------------|----------------------|--------------------|-------------------------|-----------------------|--------------------|----------------------|
| 1    |          |     |                    |       |        | Folding Door |                      |                    |                         |                       |                    |                      |
| 2    |          |     |                    |       |        | Folding Door |                      |                    |                         |                       |                    |                      |
| 3    |          |     |                    |       |        | Folding Door |                      |                    |                         |                       |                    |                      |
| 4    |          |     |                    |       |        | Folding Door |                      |                    |                         |                       |                    |                      |
| 5    |          |     |                    |       |        | Folding Door |                      |                    |                         |                       |                    |                      |
| 6    |          |     |                    |       |        | Folding Door |                      |                    |                         |                       |                    |                      |
| 7    |          |     |                    |       |        | Folding Door |                      |                    |                         |                       |                    |                      |
| 8    |          |     |                    |       |        | Folding Door |                      |                    |                         |                       |                    |                      |
| 9    |          |     |                    |       |        | Folding Door |                      |                    |                         |                       |                    |                      |
| 10   |          |     |                    |       |        | Folding Door |                      |                    |                         |                       |                    |                      |

**Purchase Order Footnotes:**

|                     |  |
|---------------------|--|
| <b>1. Mount:</b>    | (IM) - Inside Mount<br>(OM) - Outside Mount  |
| <b>3. Pattern:</b>  | Specify the fabric pattern name.   |
| <b>4. Color:</b>    | Specify the color number and name.   |
| <b>5. Stack:</b>    | (L) - One Way Stack Left<br>(R) - One Way Stack Right<br>(S) - Split Stack   |
| <b>6. Fullness:</b> | (5%) - Standard Fullness<br>(20%) - Upgrade Fullness   |
| <b>7. Liner:</b>    | (None) (PL-FL7) - Privacy Liner FL7 White<br>Additional cost applies (PL-FL4) - Privacy Liner FL4 Natural (BO-FL9) - Black Out Liner FL9 Soft White<br>(PL-FL8) - Privacy Liner FL8 Beige (BO-FL2) - Black Out Liner FL2 Beige<br>(PL-FL5) - Privacy Liner FL5 Cocoa |
| <b>8. Valance:</b>  | Specify if valance is desired. Valances are not included in the standard price grids, but are available for a surcharge.   |

**Additional Notes:**

- A deduction of 1/4" will be made to the head rail length of all Inside Mount shades.
- For Inside Mount, a deduction of 3/4" will be made to the length of all shades.
- Valance face is 8" long; board mounted 5-1/2" deep and 3/4" thick. Attached to the front edge of the board with Velcro.
- If a valance is ordered, a deduction of 1 1/2" will be made to the length to allow for the valance board.
- Valance will include 5-1/2" inch returns.
- No deduction will be made to the length of Outside Mount shades.
- One Way Draw shades stack to the Left or Right when open.
- Split Draw shades open in the middle and have magnets in the center bars for complete closure. Additional surcharge applies.

**Additional Handling Fees Apply to all Folding Doors orders:**

- \$20.00 Net per shade up to 96"
- \$50.00 Net per shade over 96"



575 West Manville Street, Rancho Dominguez, CA 90220  
 Customer Service Fax: (800) 459-6999 / International Fax: (310) 763-1749  
 PH: (800) 562-7425 / (310) 661-4400

## Purchase Order Woven Wood Valance Only

Account #: \_\_\_\_\_ Company Name: \_\_\_\_\_ Contact: \_\_\_\_\_ Purchase Order #: \_\_\_\_\_

Ship To Address: \_\_\_\_\_ Phone: \_\_\_\_\_ Sidemark: \_\_\_\_\_

City: \_\_\_\_\_ State: \_\_\_\_\_ Zip: \_\_\_\_\_ Fax: \_\_\_\_\_ Date Required: \_\_\_\_\_

EMAIL: \_\_\_\_\_ Ship Via (circle one):  FedEX  Common Carrier  Mariak Truck  Will Call

| Line | Sidemark | Qty | Mount <sup>1</sup> | Width | Length <sup>2</sup> | Shade Type   | Pattern <sup>3</sup> | Color <sup>4</sup> | Liner <sup>5</sup> |
|------|----------|-----|--------------------|-------|---------------------|--------------|----------------------|--------------------|--------------------|
| 1    |          |     |                    |       |                     | Valance Only |                      |                    |                    |
| 2    |          |     |                    |       |                     | Valance Only |                      |                    |                    |
| 3    |          |     |                    |       |                     | Valance Only |                      |                    |                    |
| 4    |          |     |                    |       |                     | Valance Only |                      |                    |                    |
| 5    |          |     |                    |       |                     | Valance Only |                      |                    |                    |
| 6    |          |     |                    |       |                     | Valance Only |                      |                    |                    |
| 7    |          |     |                    |       |                     | Valance Only |                      |                    |                    |
| 8    |          |     |                    |       |                     | Valance Only |                      |                    |                    |
| 9    |          |     |                    |       |                     | Valance Only |                      |                    |                    |
| 10   |          |     |                    |       |                     | Valance Only |                      |                    |                    |

**Purchase Order Footnotes:**

|                    |   |
|--------------------|---|
| <b>1. Mount:</b>   | (IM) - Inside Mount<br>(OM) - Outside Mount   |
| <b>2. Length:</b>  | Standard Drop/Length is 6". Additinoal surcharge appies for each additional inch.   |
| <b>3. Pattern:</b> | Specify the fabric pattern name.  |
| <b>4. Color:</b>   | Specify the color number and name.  |
| <b>5. Liner:</b>   | (None) (BO-FL9) - Black Out Liner FL9 Soft White<br>(PL-FL4) - Privacy Liner FL4 Natural (BO-FL2) - Black Out Liner FL2 Beige<br>(PL-FL8) - Privacy Liner FL8 Beige<br>(PL-FL5) - Privacy Liner FL5 Cocoa<br>(PL-FL7) - Privacy Liner FL7 White |
| <b>Note:</b>       | +30% Privacy Liner +40% Black Out Liner   |

**Additional Notes:**

- For Inside Mount, a deduction of 3/8" will be made to the width
- No deductions will be taken for Outside Mount
- Valance only orders come standard on a 1-1/2" headrail
- Valance are 6" long standard and are stapled to the front of the headrail.
- Outside Mount valance will be supplied with returns.
- Maximum valance width 96"
- Maximum valance length 24"

# Mariak

Many Window Solutions From One Source

**BLANK PAGE**

575 West Manville Street  
Rancho Dominguez, CA 90220  
(800) 562-7425  
[www.mariak.com](http://www.mariak.com)