

# Mariak

Many Window Solutions From One Source

## West Lake Woven Wood Shade Section

Effective August 6, 2012



Save a life: "Install Safety Tension Devices!"

# Mariak

Many Window Solutions From One Source

## Woven Wood Measuring Instructions

### Measuring Inside Mount (IB) Shades:

Measure the exact width (A) and length (B) of the window opening as shown. The factory will deduct ½" overall from the window width for clearance. On all inside mount shades, a small light gap will be visible.

### Measuring Outside Mount (OB) Shades:

Measure the exact width (A) and length (B) of the window opening you wish to cover. The shade should cover the window opening by at least 2" on both the width and length. To cover a window sill, provide a measurement (C) beyond the sill.

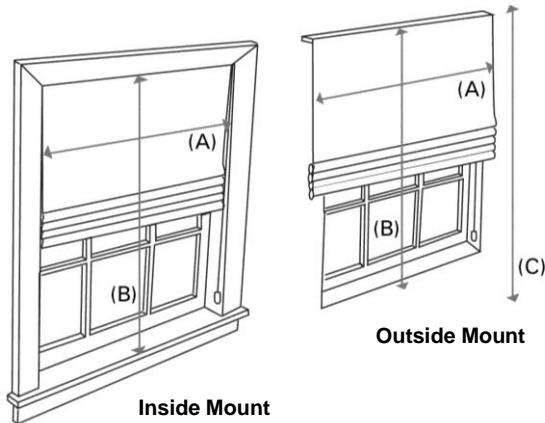

### Measuring Arch Top Valances for Woven Wood Shades:

For inside mount shades, measure the exact width and tallest length inside the window opening. For outside mount shades, measure the desired width and tallest length. Make sure to measure the length of outside mount shades at its tallest point. Arch Top woven wood shades must be perfect arches where the length equals ½ the width. For arch top valances, measure dimensions A, X, & Y. For pricing, use the width and tallest length measurement. Make sure to add the arch top shade surcharge.

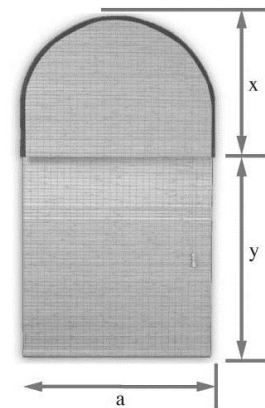

Arch Top

### Measuring Angled Shades:

It is critical to measure all four sides of the window opening. For inside mount shades, measure the inside of the window opening and for outside mount shades, add the desired overlap. Measure the slope angle with a protractor and provide the angle in degrees. Indicate all measurements on a template to be sent to the factory. For pricing, use the tallest length of the shade. For angle top valances, measure dimensions A, X, & Y. For pricing, use the width and tallest length measurement. Make sure to add the angled shade surcharge.

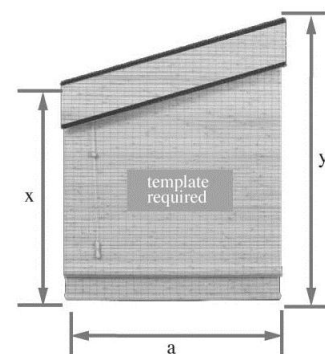

Angle Top with Angled Valance

# Mariak

Many Window Solutions From One Source

## Woven Wood Exploded Diagram

### Standard Style Woven Wood Shade

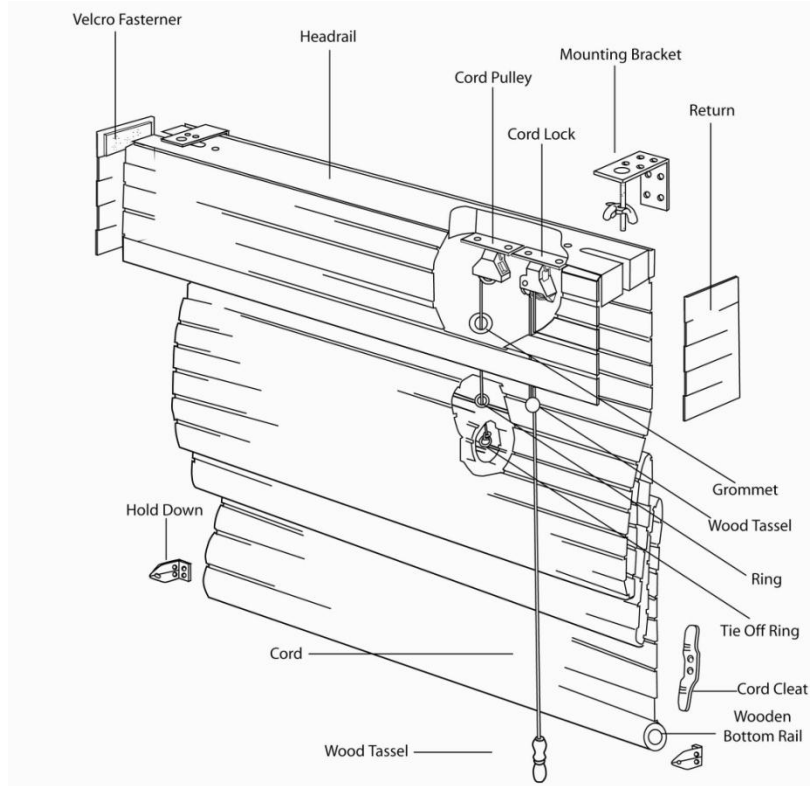

### Folding Door Style Woven Wood Shade

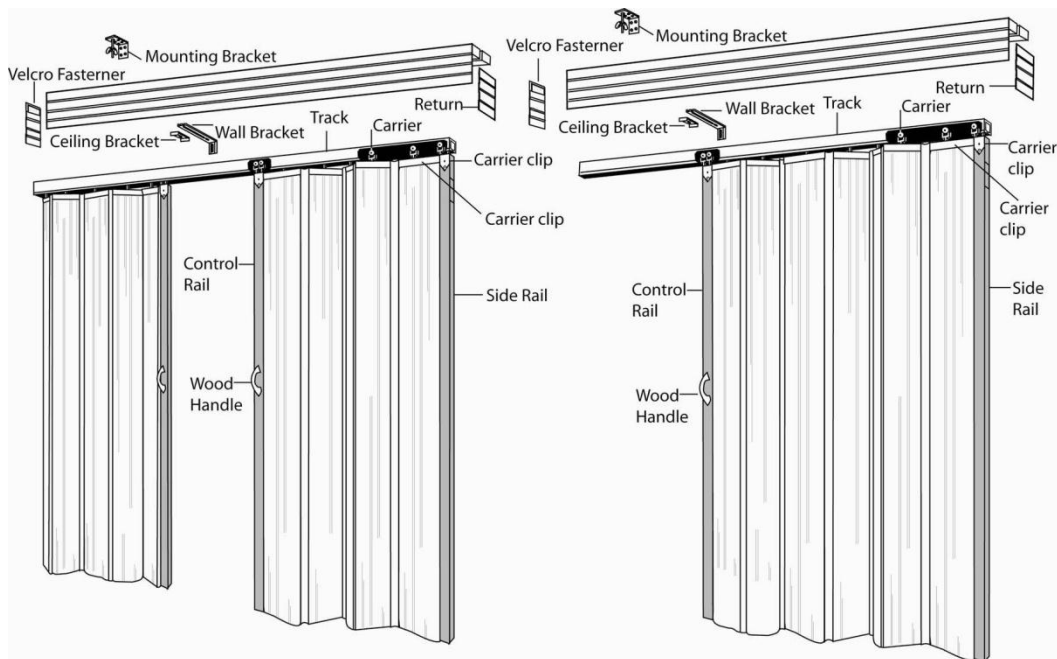

Split Draw

One Way Draw

# Mariak

Many Window Solutions From One Source

## Woven Wood Shade Options

### Standard Style Woven Wood Shade

The Standard Style woven wood shade has the lift control cord in *front* of the shade. When completely down, the shade lays flat covering the window. When raised, the material rises from the bottom in flat folds. This shade option includes a 6" valance.

Minimum Width: 12"  
Maximum Width: 96"  
Minimum Height: 12"  
Maximum Height: 108"

Optional Continuous Cord Loop is available.  
See Retail Price Tables for surcharge.

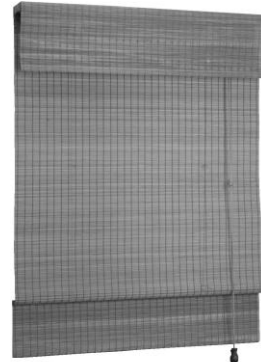

### Waterfall Style Woven Wood Shade

The Waterfall Style woven wood shade offers the lift control cord *behind* the shade. The material is attached to the front of the headrail without a valance. When completely down, the shade lays flat covering the window. When raised, the material rises from the bottom in flat folds.

Minimum Width: 12"  
Maximum Width: 96"  
Minimum Height: 12"  
Maximum Height: 108"

Optional Continuous Cord Loop is available.  
See Retail Price Tables for surcharge.



### Twin Style Woven Wood Shade

The Twin style shade features two separate, independently operated shades on one headrail. The front shade may be either a Standard Style shade or a Waterfall Style shade in natural woven wood material. A separate liner shade is attached to the back of the headrail. Both shades operate independently with lift cords at opposite sides of the shade. Available with Edge Binding and Wood Bars.

Minimum Width: 12"  
Maximum Width: 96"  
Minimum Height: 12"  
Maximum Height: 108"

Optional Continuous Cord Loop is available for both Front Shade only and for Front Shade and Back Liner. If this option is selected for both Front Shade and Back Liner, add the Cord Loop surcharge twice.  
See Retail Price Tables for surcharge.

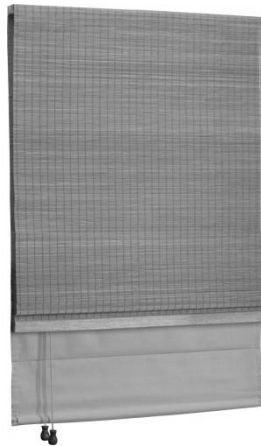

### Continuous Loop Style Woven Wood Shade

The continuous loop style woven wood shade has a clutch lift mechanism that provides easier lifting of the shade and eliminates cord tangling. The control cord for this style of shade will always remain the same length. This option is available for Standard, Waterfall, and Twin Style Shades. It features an automatic locking device, which allows the shade to be stopped at any position. This option is strongly recommended for very large or heavy woven wood shades.

Continuous Loop Surcharge...Price as a standard shade and add the surcharge listed at the bottom of each Suggested Retail Price Table.

Minimum Width: 18"  
Maximum Width: 96"  
Minimum Height: 12"  
Maximum Height: 108"

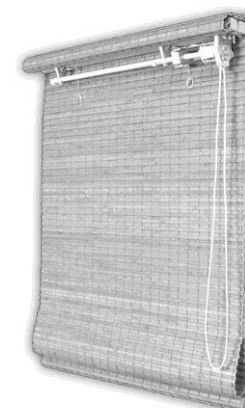

# Mariak

Many Window Solutions From One Source

## Top-Down/Bottom-Up Style Woven Wood Shade

The top-down/bottom-up style woven wood shade can be raised from the bottom or lowered from the top by two sets of lift cords located on opposite sides of the shade. The lift cords will be located in *front* of the shade. A 6" lined valance will be included to conceal the operating hardware and is included in the surcharge. When raised, the material rises from the bottom in flat folds. The top-down/bottom-up option is available with only with Standard Style shades.

Top-Down/Bottom-Up Surcharge.....\$ 45.00 Net Per Shade

Minimum Width: 18"  
Maximum Width: 60"  
Minimum Height: 18"  
Maximum Height: 72"

This option is not available for 3-On-1 headrail shades.  
This option is not available with Continuous Cord Loop.

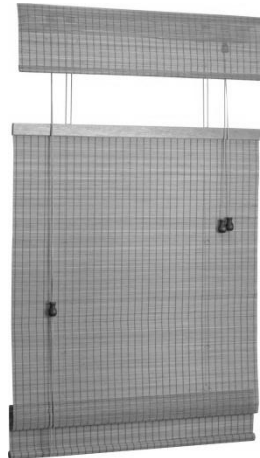

## Arch Top Style Woven Wood Shade

This shade option includes an arch top style valance. A coordinating edge binding trim is included for this valance and a template for the arch is required.

- Arch Top Surcharge.....\$60.00 Net Per Shade

Minimum Width: 18"  
Maximum Width: 72"  
Minimum Height: 18"  
Maximum Height: 72"

This option is not available with Continuous Cord Loop.

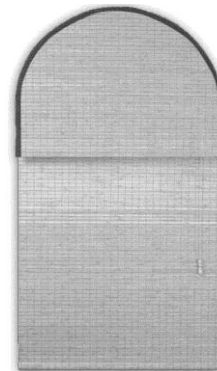

## Angle Top Style Woven Wood Shade

This shade option includes an angle top with an angled valance.

- Angle Top Surcharge.....\$ 40.00 Net Per Shade

Minimum Width: 18"  
Maximum Width: 72"  
Minimum Height: 18"  
Maximum Height: 72"

*This option is not available with Continuous Cord Loop.*

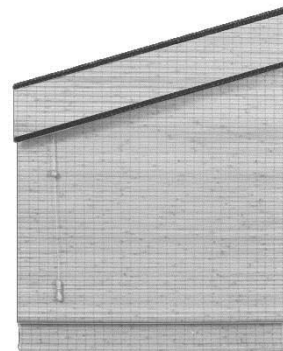

## Multiple Woven Wood Shades On One Headrail

The multiple shades on 1 headrail option is a reasonable choice for large openings. The opening width is split into 2 or 3 individual shades with one common valance. Price as one overall shade and add the applicable surcharge listed below.

- 2—on—1 Headrail Surcharge...\$ 20.00 Net Per Opening
- 3—on—1 Headrail Surcharge...\$ 25.00 Net Per Opening

Minimum Width: 36"  
Maximum Width: 96"  
Minimum Height: 18"  
Maximum Height: 108"

-Optional Continuous Cord Loop is available.  
-Maximum width for a common valance is 96".  
-Maximum light gap between shades will be 1/2".  
-See Retail Price Tables for surcharge.

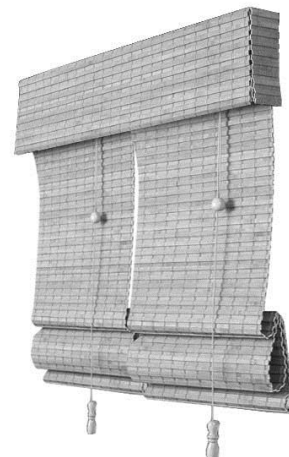

# Mariak

Many Window Solutions From One Source

## Folding Door Style Woven Wood Shade

The folding door style woven wood shade is optimal for sliding glass doors. They may also be used as room dividers. Folding door shades are only recommended for outside mount installations. Edge binding is not an available option for this style of shade. Please note that the fabric used for folding door shades are railroaded, or turned 90° sideways. A valance is not included, but is available for an additional surcharge. The direction of the fabric used to make the valance will be cut straight or opposite the way it appears in the folding door shade.

Minimum Width: 24"  
 Maximum Width: 192"  
 Minimum Height: 24"  
 Maximum Height: 96"

- Bamboo Wood Bars, handles & screws provided with each door.
- Available in One-Way Left or Right as standard.
- Center opening available for an additional surcharge.
- Standard 5% fullness; door lies nearly flat when fully extended.
- 20% Fullness options for an additional surcharge.
- Liners are available and will be attached to the top of the folding door and secured down both sides beneath the bamboo wood bars.
- Optional Valance is 8" long and is mounted to a wood board 5-1/2" deep and 3/4" thick. Attached to the front edge of the board by Velcro.
- Edge Binding is not available on Folding Door Shades.
- Inside Mount shades the valance will cover the front of the valance board only; Outside Mount shades the valance will wrap around both ends of the board.
- Bracket dimension is 3" Deep x 1-1/2" High

### Doors without a Valance –

The height of the folding door is measured from the top of the track to the bottom of the fabric. There is a gap of approximately 3/4" between the top of the track and the material. The factory will deduct this amount from the ordered length.

### Doors with a Valance –

The height of the folding door is measured from the top of the valance board to the bottom of the fabric. The valance board is 3/4" thick and there is 3/4" between the top of the track and the top of the material. The factory will deduct 1-1/2" from the ordered length.

### Inside Mount Measurements –

Minimum Inside Mount Depth is 2"  
 Check for any obstructions such as trim or handles that may interfere with the opening and closing of the door.

### Inside Mount Deductions:

Width: 1/4" Height: 3/4"

No deductions are made to the width or height of Outside Mount Door.

STACK CHART	
5% Fullness	
Width	Stack
36"	8-1/2"
42"	9"
48"	9-1/2"
60"	11"
72"	12"
84"	13"
96"	14"

Center opening shades will open into two equal stacks on each side.

20% Fullness shades will stack approximately 1" wider for small shades and 1-1/2" wider for larger shades.

All stacking dimensions are approximate and will vary by pattern

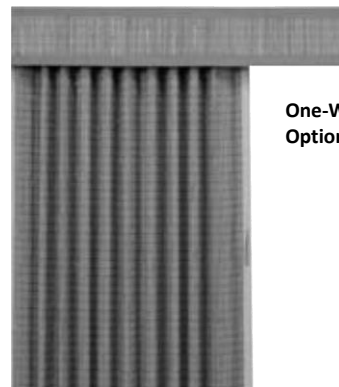

One-Way Left Stack with Optional Valance



Center Opening with Optional Valance



Center Opening shown without valance



5% Fullness



20% Fullness

# Mariak

Many Window Solutions From One Source

## Lining Options:

### **Privacy Lining:**

Provides complete privacy & filters light by more than 50%.

### **Black-Out Lining:**

Provides complete privacy and blocks sunlight with the exception of side light gaps.

**Surcharges will apply.**



## Wood Bottom Bars:

Available with all patterns and up to 96" wide. Not available with Edge Binding. Tassels will be coordinated to the pattern and cords, not to the wood bar.

**Surcharges will apply.**

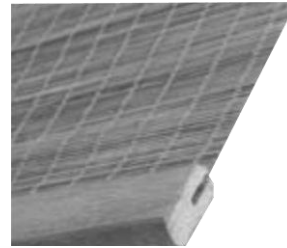

## Edge Binding Options:

Edge binding is an excellent method of both protecting the ends of the shade fabric and adding a color accent to the shade. Wide Edge binding is 3" in width (1 1/2" on the face of the shade). Narrow Edge Binding is 1-1/2" (3/4" on the face of the shade). It is applied to the sides of the shade and valance and (if applicable) across the bottom of the shade.

- Not available with Hold Downs or Wood Bottom Bars.

**Surcharges will apply.**

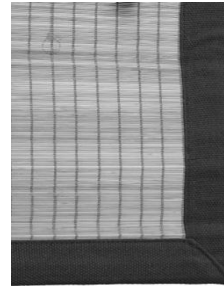

# Mariak

Many Window Solutions From One Source

## Woven Wood Shade Motorization

### Motorized Woven Wood Shade

Woven Wood Shades can be powered by a variety of motors. At the press of a button, shades can be raised up, exposing a room to sunlight, or lowered down, Filtering Light from a room. Motorized Woven Woods will have a lift cord in back; the motor is in a tube and the cords roll-up onto the tube.

#### Battery Powered Radio Frequency Motors:

Smaller shades may be operated by a battery powered motor system. This unique motor system has full lift control of shades that are up to 12.5 lbs. The motor is powered by AA lithium battery packs, which can be mounted to the ceiling or installed to the wall. The battery life expectancy is 1 to 2 years (based upon 2 operations per day and the weight of the shade). Battery Powered Woven Wood Shades are available with radio frequency controls. These motors have a built-in radio frequency receiver that communicates with a hand held remote control transmitter or a wireless wall switch via radio waves. Woven Wood Shades controlled by radio frequency may be operated as an individual unit, as sub-groups, and as an entire group. Please consult Mariak technical support with any questions you may have.



RF Hand-Held Transmitters & Wireless Wall Switches are available in 1 & 5 Channel models

	<b>Battery Powered Motor Surcharges:</b>	
Minimum Width: 24"	Battery Powered Motor (Radio Frequency – 12 Volt)	\$400.00 (Net Pricing)
Maximum Width: 72"	Radio Frequency Transmitter 1-Ch	\$ 61.00 (Net Pricing)
Minimum Height: 24"	Radio Frequency Transmitter 5-Ch	\$ 80.00 (Net Pricing)
Maximum Height: 72"	Radio Frequency Wireless Wall Switch 1-Ch	\$146.00 (Net Pricing)
	Radio Frequency Wireless Wall Switch 5-Ch	\$153.00 (Net Pricing)

#### 24-Volt DC (Low Voltage) Powered Plug-In or Hardwired Radio Frequency Motors:

This Woven Wood Shade is operated by a 24-volt DC 2-wire motor. The motor may be plugged-in to a standard electrical wall outlet with a 24-volt transformer or hardwired via low voltage wiring if desired. A variety of low voltage transformers are available for an additional charge. These motors have a built-in radio frequency receiver that communicates with a hand held remote control transmitter or a wireless wall switch via radio waves. The electronic controls for this type of motor are capable of operating a shade individually, as sub-groups, and as an entire group. Please consult Mariak technical support with any questions you may have.

	<b>24-Volt DC (Low Voltage) Powered Motor Surcharges:</b>	
Minimum Width: 24"	DC Powered Motor (Radio Frequency – 12 Volt)	\$415.00 (Net Pricing)
Maximum Width: 96"	Radio Frequency Transmitter 1-Ch	\$ 61.00 (Net Pricing)
Minimum Height: 24"	Radio Frequency Transmitter 5-Ch	\$ 80.00 (Net Pricing)
Maximum Height: 96"	Radio Frequency Wireless Wall Switch 1-Ch	\$146.00 (Net Pricing)
	Radio Frequency Wireless Wall Switch 5-Ch	\$153.00 (Net Pricing)

*Please consult Mariak technical support for assistance with selecting and pricing the appropriate low voltage transformer.*

**110-Volt AC Powered Plug-In Radio Frequency Motors: (Most Popular Motor Option!)** This Woven Wood Shade is operated by a 110-volt AC 3-wire motor. The motor may be plugged-in to a standard 3-prong electrical wall outlet or hardwired if desired. For your convenience, the shade is shipped from the factory with a plug installed at the end of the motor cable. If so desired, the plug may be cut off and hardwired to a dedicated power supply by a licensed electrician. These motors have a built-in radio frequency receiver that communicates with a hand held remote control transmitter or a wireless wall switch via radio waves. The electronic controls for this type of motor are capable of operating a shade individually, as sub-groups, and as an entire group. Please consult Mariak technical support with any questions you may have.

	<b>110-Volt AC Powered Plug-In Radio Frequency Motor Surcharges:</b>	
Minimum Width: 30"	AC Powered Plug-In Motor (Radio Frequency – 110 Volt)	\$420.00 (Net Pricing)
Maximum Width: 96"	Radio Frequency Transmitter 1-Ch	\$ 61.00 (Net Pricing)
Minimum Height: 24"	Radio Frequency Transmitter 5-Ch	\$ 80.00 (Net Pricing)
Maximum Height: 96"	Radio Frequency Wireless Wall Switch 1-Ch	\$146.00 (Net Pricing)
	Radio Frequency Wireless Wall Switch 5-Ch	\$153.00 (Net Pricing)

#### 110-Volt AC Powered Standard Hardwired Motors:

This Woven Wood Shade is operated by a 110-volt AC 4-wire motor. It requires the motor to be hardwired or installed such that the power supply must be fixed and permanent. In other words, wires from a power source within the wall must be connected by a licensed electrician so that the motor receives a constant power supply at all times. A variety of electronic controls for hardwired motorized Woven Wood Shades are capable of operating a shade individually, as sub-groups, and/or as an entire group. Please consult Mariak technical support with any questions you may have.

	<b>110-Volt AC Powered Standard Hardwired Motor Surcharges:</b>	
Minimum Width: 30"	AC Powered Plug-In Motor (Hardwired – 110 Volt)	\$385.00 (Net Pricing)
Maximum Width: 96"	Basic Wall Switch	\$ 20.00 (Net Pricing)
Minimum Height: 24"	(A wide variety of hardwired motor group controllers are available upon request.)	
Maximum Height: 96"		



## Additional Woven Wood Shade Information

**Factory Deductions:** Inside mount shades have a  $\frac{3}{8}$ " deduction in width.

### Fabric Information:

**Yarns** – A wide array of natural and manmade fibers are used in the making of the yarns featured in woven wood fabrics. Pure, bright colors are achieved by using the finest dyes available. Even so, over a period of time slight fading may occur.

**Stretching** – All natural woven wood shades may stretch; this is an inherent trait for these fabrics.

**Color Variation** – Both the paints and stains on natural fabrics are subject to color variation. Reed and wood slats will retain the unique grain, nodes, color, and shape irregularities inherent from natural woods, water reeds, and grasses.

**Fading** – Over an extended period of time, exterior and interior discoloration may occur. The colors may become more yellow after exposed to strong sunlight. The use of a privacy lining will minimize fading.

**Stretching, Color Variation, and Fading are natural characteristics of woven wood shades. The occurrence of these changes is industry standard and will not warrant a replacement shade.**

**Energy Savings** – Woven wood fabrics are a good insulator against the summer's heat and winter's cold.

### Headrail Dimensions:

Headrail Type	Dimensions
Standard Pull Cord (Cord Lock) Woven Wood Shades	1 ½" x ¾"
Continuous Cord Loop, Battery Motors, & DC (Low Voltage) Motors Twin Shade with Standard Pull Cord for both Front Shade & Back Liner	2 ½" x ¾"
AC (High Voltage) Motorized Woven Wood Shades Twin Shade with Cord Loop Front Shade & Pull Cord Back Liner	3" x ¾"
Twin Shade with Cord Loop for both Front Shade & Back Liner	5" x ¾"

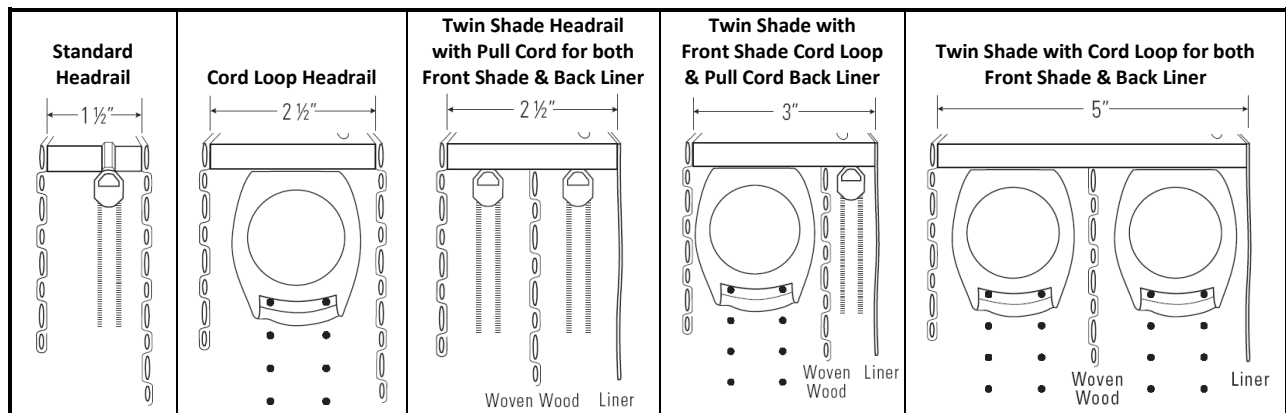

### Stack Height Chart:

Height of Shade	Total Thickness
	Traditional Roman Fold
Up To ~84"	~9"
85 - 120"	~10"

Note: These are estimated measurements and may vary from shade type to shade type and fabric to fabric.

### Cleaning Instructions:

Woven wood shades are designed to be durable and are easily cleaned. These fabrics are inherently anti-static and repel dust. Occasional feather dusting or light vacuuming may be necessary to keep the fabrics clean and bright.

# Mariak

Many Window Solutions From One Source

## Bracket Dimensions

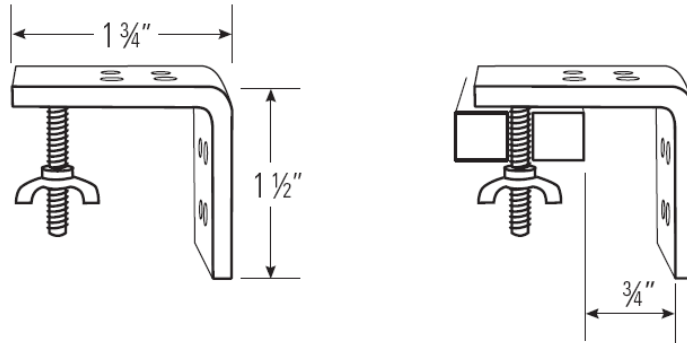

### Inside Mount Depths:

**Minimum Required Depth:** 3/4" with standard bracket

**Flush Mount Required Depth:** Headrail size plus 1" if using standard bracket.

Exact flush inside mount depths will vary slightly based upon the thickness of the fabric selected.

### Safety Information:

To insure child safety, it is strongly recommended that each shade be installed with a cord safety cleat provided by the manufacturer.

### No Charge Options:

Valance returns are supplied with all outside mount shades and are available upon request with inside mount shades.

Standard valance returns are 6" long and are made of the bamboo pattern chosen.

Hold-Down Brackets are available upon request, but are not available with Edge Binding or Wood Bottom Bar options.

Spacer Blocks are available upon request.

### Fabric Valance Returns:

For shades with edge binding, returns made from the edge binding fabric are available as a surcharge option.

### Lined Valance:

Lined valances are recommended to conceal the headrail components when an open-weave pattern is selected. This is particularly recommended if clutch controls are chosen as these components are more visible through the valance. All Top-Down/Bottom-Up shades will be shipped with lined valance as standard.

### Cut Outs:

Cut outs can be taken from either side of the shade. Please provide exact dimensions and the locations of the cut outs required. There may be limitations to what can be cut out, based on the size and specifications of the shade.

### Cord Shrouds:

Cords on the back of the shade are wrapped in a "cord shroud" for increased safety against strangulation hazard. This allows the shade to fold normally, but does not allow a hazardous loop to be formed since the lift cord cannot be pulled out on the back of the shade any further than the spacing between the lift rings.



Surcharge of \$ 1.50 per shade will automatically be applied to all Woven Wood Shades.

In compliance with the latest manufacturing safety guidelines Mariak Window Fashions includes with each fully-assembled product warning tags, warning labels, safety devices and cord cleats. Installers of the finished product must adhere to the safety guidelines as established by the installation instructions and by using all devices provided by the manufacturer. It is the responsibility of the installer, as well as the end consumer, to see that all safety devices are properly installed according to the manufacturers installation instructions included with each device and remain so throughout the life of the product. Mariak Window Fashions is not liable for injuries or fatal occurrences related to improper installation or maintenance of required safety devices.



# Mariak

Many Window Solutions From One Source

## West Lake Woven Wood Pattern Index

Pattern	Color Code	Price Table	Edge Binding	Folding Door	Recommended Wood Bottom Bar Color
ABACA BEIGE	WL 8811B	D	*Y (Wide Edge Binding Recommended)	N/A	Sugar Maple
ABACA EARTH	WL 7231E	D	*Y (Wide Edge Binding Recommended)	Y	Walnut
ABACA RED EARTH	WL 8811R	D	*Y (Wide Edge Binding Recommended)	N/A	Spice
ABACA SAGE	WL 8813S	D	*Y (Wide Edge Binding Recommended)	N/A	Driftwood
AKITA CARBON	WL 3100R	C	Y	Y	Sugar Maple
AKITA HAZELNUT	WL 3030H	C	Y	Y	Espresso
AKITA OAK	WL 3010K	C	Y	Y	Walnut
AKITA WALNUT	WL 3050W	C	Y	Y	Walnut
ASPEN WALNUT	WL 8082W	B	Y	Y	Spice
BAJA SAND	WL 8051S	A	Y	Y	Natural
BAMBOO FOREST GREEN	WL 0122G	C	Y	Y	Sugar Maple
BAMBOO PALM CARBON	WL 4100R	C	Y	Y	Driftwood
BAMBOO PALM DARK OAK	WL 4100D	C	Y	Y	Spice
BAMBOO PALM ESPRESSO	WL 4100E	C	Y	Y	Espresso
BAMBOO PALM WALNUT	WL 4100W	C	Y	Y	Spice
BAMBOO REEDS WHEAT	WL 2040W	B	N/A	N/A	Natural
BAMBOO WEAVE CAMEL	WL 2060C	B	N/A	N/A	Sugar Maple
BORA BORA NATURAL	WL 8861N	B	Y (Edge Binding Recommended)	Y	Natural
CABANA PECAN	WL 8036P	B	Y	Y	Spice
CABANA SADDLE	WL 8036S	B	Y	Y	Sugar Maple
CARIBE SPICE	WL 5243S	D	*Y	N/A	Walnut
CORONADO WHITE SAND	WL 8056W	D	Y (Wide Edge Binding Recommended)	N/A	Natural
DRIFTWOOD NATURAL	WL 5068N	A	Y	Y	Natural
FIJI NATURAL	WL 0121N	A	Y	Y	Natural
FOREST GRASS SAGE	WL 0235S	C	*Y	Y	Driftwood
HANA NATURAL	WL 8025N	C	*Y	Y	Natural
HARMONY NATURAL	WL 4970N	D	*Y	N/A	Natural
HARMONY SPICE	WL 4970S	D	*Y	N/A	Walnut
KOWLOON BAY	WL 8050K	B	Y	Y	Sugar Maple
KYOTO BROWN	WL 5646B	A	Y	Y	Walnut
KYOTO MERLOT	WL 5647M	A	Y	Y	Spice
LAGUNA UMBER	WL 8867U	A	N/A	N/A	Sugar Maple
LATTICE TWILIGHT	WL 8074D	A	Y	Y	Espresso
MANDALAY OAK	WL 5087K	A	Y	Y	Sugar Maple
MANDALAY PISTACHIO	WL 5052P	A	Y	Y	Natural
MEDAN CARMEL	WL 5056C	A	Y	N/A	Sugar Maple
MONTEREY OAK	WL 6914K	A	Y	Y	Sugar Maple
NOCTURNE EBONY	WL 5186E	B	Y	Y	Natural
PANAMA CEDAR	WL 8044C	A	Y	Y	Spice
PARCHMENT BLEACHED	WL 7253B	C	Y (Wide Edge Binding Recommended)	N/A	Natural
PENANG OAK	WL 5057K	A	Y	Y	Sugar Maple
PRAIRIE BRUSHWOOD	WL 0209B	C	*Y	N/A	Walnut
PRAIRIE NATURAL	WL 7249N	D	*Y	N/A	Driftwood
PRAIRIE RUSSET	WL 7254R	D	*Y	N/A	Spice
RAFFIA BARK	WL 7252B	D	*Y	N/A	Walnut

# Mariak

Many Window Solutions From One Source

## West Lake Woven Wood Pattern Index (continued)

Pattern	Color Code	Price Table	Edge Binding	Folding Door	Recommended Wood Bottom Bar
RUSTIC PECAN	WL 8021P	A	Y	Y	Walnut
RUSTIC TAN	WL 8017T	A	Y	Y	Sugar Maple
SAVANNA NIGHTSHADE	WL 7415N	D	*Y	N/A	Espresso
ST. MARTIN CAPPUCCINO	WL 8031C	D	Y (Edge Binding Recommended)	Y	Walnut
SUMATRA ESPRESSO	WL 5002E	B	Y	N/A	Espresso
SUMATRA SADDLE	WL 5002S	B	Y	N/A	Walnut
SUN SHADE BROWN	WL 5049B	B	Y	Y	Walnut
SUN SHADE NATURAL	WL 5049N	B	Y	Y	Natural
SUN SHADE WHITE	WL 5049W	C	Y	N/A	Natural
TAMARIND BROWN	WL 7248B	C	Y	Y	Spice
TERRA OAK	WL 9077K	D	*Y	Y	Sugar Maple
TIKI CARBON	WL 0120C	A	Y	Y	Walnut
WESTPORT NUTMEG	WL 8865N	B	*Y	N	Spice

*Edge binding is recommended on certain fabrics as the edges can become easily damaged and the treads tend to unravel.*

*\*Narrow edge binding not recommended with these patterns.*

### Edge Binding Color Reference

CREAM	T001, W001
DARK BEIGE	T003, W003
DESERT SAND	T005, W005
MOCHA	T007, W007
PECAN	T009, W009
CHOCOLATE	T010, W010
KHAKI	T012, W012
LIGHT OLIVE	T013, W013
BERRY	T014, W014
BLACK	T015, W015
<b>T - Narrow    W-Wide</b>	

### Wood Bar Color Reference

WALNUT	WB03
DRIFTWOOD	WB05
NATURAL	WB06
SPICE	WB10
ESPRESSO	WB14
SUGAR MAPLE	WB15

### Liner Color Reference

Liner Color Name	Color Number	Backing Color
PRIVACY NATURAL	FL4	NATURAL
PRIVACY BEIGE	FL8	BEIGE
PRIVACY COCOA	FL5	COCOA
PRIVACY WHITE	FL7	WHITE
BLACK-OUT SOFT WHITE	FL9	WHITE
BLACK-OUT BEIGE	FL2	OFF WHITE



## West Lake Woven Wood Shades Standard & Waterfall Style Shades

**Suggested Retail Price - Table A**

Width	24	30	36	42	48	60	72	84	96
36	94	119	145	162	180	222	250	291	320
48	132	152	171	194	214	267	299	350	386
54	141	171	185	207	234	290	330	378	421
60	149	178	200	222	244	309	362	406	456
66	157	185	214	237	263	353	389	448	504
72	165	196	228	253	279	369	410	491	551
78	176	209	242	273	304	392	444	520	586
84	186	222	257	291	330	415	468	551	628
90	195	233	271	307	345	449	522	594	675
96	204	245	286	324	362	473	542	632	720
108	230	276	322	365	407	532	609	711	810
Roll Ease Cord Loop Clutch System	90	105	120	130	135	140	150	160	170
Wood Bottom Bar	13	16	18	20	22	27	31	36	40

Note: Shades measuring more than 72" in width are recommended with a continuous cord loop control.

Baja Sand	Laguna Umber	Monterey Oak	Tiki Carbon
Driftwood Natural	Lattice Twilight	Panama Cedar	
Fiji Natural	Mandalay Oak	Penang Oak	
Kyoto Brown	Mandalay Pistachio	Rustic Pecan	
Kyoto Merlot	Medan Camel	Rustic Tan	

<b>Woven Wood Surcharge Options</b>			
Top-Down/Bottom-Up	\$45.00 Net	Arch Top	\$60.00 Net
Edge Binding Fabric Valance Returns	\$15.00 Net	Angle Top	\$40.00 Net
Custom Cord Loop Length	\$20.00 Net		
Metal Bead Chain	\$20.00 Net		
Cutouts	\$15.00 Net Per Cutout		
Two-On-One Headrail	\$20.00 Net (price as one overall shade)		
Three-On-One Headrail	\$25.00 Net (price as one overall shade)		
Liners - Refer to Liner Price Tables			
Edge Binding - Refer to Edge Binding Price Tables			
Shades up to 92" in width shipped via FedEx: \$ 4.00 per unit Net Freight Charge			
Shades 92 1/8" to 125" in width shipped via FedEx: \$ 75.00 per unit Net Freight Charge			
Shades 125 1/8" or greater in width shipped via Common Carrier: \$ 150.00 per shipment			

**Surcharge of \$ 1.50 per shade will automatically be applied to all Woven Wood Shades for Cord Shrouds.**

All prices are in U.S. dollars and do not include freight, duties or taxes for shipment to Alaska, Hawaii or Canada. GST and VAT are not included. Other restrictions and surcharges may apply. See freight policy for complete details.

**Manufacturing specifications, options, surcharges and pricing are subject to change without notice.**

Visit [www.mariak.com](http://www.mariak.com) for most recent downloads.

## West Lake Woven Wood Shades Standard & Waterfall Style Shades

**Suggested Retail Price - Table B**

Width	24	30	36	42	48	60	72	84	96
36	128	155	182	198	214	250	285	335	381
48	170	196	222	244	266	303	342	406	475
54	177	207	236	261	285	328	371	441	510
60	186	218	250	277	303	353	400	475	545
66	196	231	265	294	323	377	430	507	579
72	206	243	280	311	342	400	460	539	612
78	215	255	295	329	362	425	489	570	648
84	224	267	309	345	381	450	518	601	683
90	235	280	324	362	400	485	560	648	733
96	245	305	338	379	419	520	602	694	783
108	276	329	380	426	471	585	677	781	880
Roll Ease Cord Loop Clutch System	90	105	120	130	135	140	150	160	170
Wood Bottom Bar	13	16	18	20	22	27	31	36	40

Note: Shades measuring more than 72" in width are recommended with a continuous cord loop control.

Aspen Walnut	Cabana Pecan	Sumatra Espresso	Westport Nutmeg
Bamboo Reeds Wheat	Cabana Saddle	Sumatra Saddle	
Bamboo Weave Camel	Kowloon Bay	Sun Shade Brown	
*Bora Bora Natural	Noctune Ebony	Sun Shade Natural	

\* Edge Binding Recommended

<b>Woven Wood Surcharge Options</b>			
Top-Down/Bottom-Up	\$45.00 Net	Arch Top	\$60.00 Net
Edge Binding Fabric Valance Returns	\$15.00 Net	Angle Top	\$40.00 Net
Custom Cord Loop Length	\$20.00 Net		
Metal Bead Chain	\$20.00 Net		
Cutouts	\$15.00 Net Per Cutout		
Two-On-One Headrail	\$20.00 Net (price as one overall shade)		
Three-On-One Headrail	\$25.00 Net (price as one overall shade)		
Liners - Refer to Liner Price Tables			
Edge Binding - Refer to Edge Binding Price Tables			
Shades up to 92" in width shipped via FedEx: \$ 4.00 per unit Net Freight Charge			
Shades 92 1/8" to 125" in width shipped via FedEx: \$ 75.00 per unit Net Freight Charge			
Shades 125 1/8" or greater in width shipped via Common Carrier: \$ 150.00 per shipment			

Surcharge of \$ 1.50 per shade will automatically be applied to all Woven Wood Shades for Cord Shrouds.

All prices are in U.S. dollars and do not include freight, duties or taxes for shipment to Alaska, Hawaii or Canada. GST and VAT are not included. Other restrictions and surcharges may apply. See freight policy for complete details.

Manufacturing specifications, options, surcharges and pricing are subject to change without notice.

Visit [www.mariak.com](http://www.mariak.com) for most recent downloads.

# Mariak

Many Window Solutions From One Source

## West Lake Woven Wood Shades Standard & Waterfall Style Shades

**Suggested Retail Price - Table C**

	Width	24	30	36	42	48	60	72	84	96
Length	36	157	181	204	217	243	301	351	429	494
	48	177	206	234	252	270	349	407	492	582
	54	189	220	251	272	292	369	446	536	614
	60	201	234	267	290	319	401	470	563	661
	66	213	248	282	307	342	433	510	609	708
	72	224	261	297	324	361	471	554	660	765
	78	236	275	314	349	392	499	586	698	810
	84	247	289	330	373	415	526	618	735	855
	90	258	302	346	391	435	562	659	781	908
	96	269	316	362	409	463	597	710	834	961
	108	303	356	407	460	521	672	799	938	1081
	Roll Ease Cord Loop Clutch System	90	105	120	130	135	140	150	160	170
	Wood Bottom Bar	13	16	18	20	22	27	31	36	40

Note: Shades measuring more than 72" in width are recommended with a continuous cord loop control.

- |                |                      |                     |                   |
|----------------|----------------------|---------------------|-------------------|
| Akita Carbon   | Bamboo Forest Green  | Bamboo Palm Walnut  | Prairie Brushwood |
| Akita Hazelnut | Bamboo Palm Carbon   | Forest Grass Sage   | Sun Shade White   |
| Akita Oak      | Bamboo Palm Dark Oak | Hana Natural        | Tamarind Brown    |
| Akita Walnut   | Bamboo Palm Espresso | *Parchment Bleached |                   |

\* Wide Edge Binding Recommended

<b>Woven Wood Surcharge Options</b>			
Top-Down/Bottom-Up	\$45.00 Net	Arch Top	\$60.00 Net
Edge Binding Fabric Valance Returns	\$15.00 Net	Angle Top	\$40.00 Net
Custom Cord Loop Length	\$20.00 Net		
Metal Bead Chain	\$20.00 Net		
Cutouts	\$15.00 Net Per Cutout		
Two-On-One Headrail	\$20.00 Net (price as one overall shade)		
Three-On-One Headrail	\$25.00 Net (price as one overall shade)		
Liners - Refer to Liner Price Tables			
Edge Binding - Refer to Edge Binding Price Tables			
Shades up to 92" in width shipped via FedEx: \$ 4.00 per unit Net Freight Charge			
Shades 92 1/8" to 125" in width shipped via FedEx: \$ 75.00 per unit Net Freight Charge			
Shades 125 1/8" or greater in width shipped via Common Carrier: \$ 150.00 per shipment			

**Surcharge of \$ 1.50 per shade will automatically be applied to all Woven Wood Shades for Cord Shrouds.**

All prices are in U.S. dollars and do not include freight, duties or taxes for shipment to Alaska, Hawaii or Canada. GST and VAT are not included. Other restrictions and surcharges may apply. See freight policy for complete details.

Manufacturing specifications, options, surcharges and pricing are subject to change without notice.

Visit [www.mariak.com](http://www.mariak.com) for most recent downloads.



**West Lake Woven Wood Shades  
Standard & Waterfall Style Shades**

**Suggested Retail Price - Table D**

Width	24	30	36	42	48	60	72	84	96
36	188	216	243	260	276	351	409	497	586
48	214	242	281	303	325	413	484	583	682
54	227	268	309	329	349	442	521	625	732
60	240	289	327	355	373	472	558	668	780
66	254	301	347	372	397	539	620	730	850
72	268	312	356	389	422	566	666	793	919
78	279	327	375	421	459	598	704	838	972
84	295	344	394	445	496	630	742	880	1025
90	309	362	414	467	520	679	819	972	1126
96	323	379	434	476	545	729	858	1019	1179
108	363	426	488	536	613	820	965	1146	1326
Roll Ease Cord Loop Clutch System	90	105	120	130	135	140	150	160	170
Wood Bottom Bar	13	16	18	20	22	27	31	36	40

Note: Shades measuring more than 72" in width are recommended with a continuous cord loop control.

\*Abaca Beige

\*Coronado White Sand

Raffia Bark

\*Abaca Earth

Harmony Natural

\*\*St. Martin Cappuccino

\*Abaca Red Earth

Harmony Spice

Savanna Nightshade

\*Abaca Sage

Prairie Natural

Terra Oak

Caribe Spice

Prairie Russet

\* Wide Edge Binding Recommended

\*\* Edge Binding Recommended

**Woven Wood Surcharge Options**

Top-Down/Bottom-Up	\$45.00 Net	Arch Top	\$60.00 Net
Edge Binding Fabric Valance Returns	\$15.00 Net	Angle Top	\$40.00 Net
Custom Cord Loop Length	\$20.00 Net		
Metal Bead Chain	\$20.00 Net		
Cutouts	\$15.00 Net Per Cutout		
Two-On-One Headrail	\$20.00 Net (price as one overall shade)		
Three-On-One Headrail	\$25.00 Net (price as one overall shade)		
Liners - Refer to Liner Price Tables			
Edge Binding - Refer to Edge Binding Price Tables			
Shades up to 92" in width shipped via FedEx: \$ 4.00 per unit Net Freight Charge			
Shades 92 1/8" to 125" in width shipped via FedEx: \$ 75.00 per unit Net Freight Charge			
Shades 125 1/8" or greater in width shipped via Common Carrier: \$ 150.00 per shipment			

Surcharge of \$ 1.50 per shade will automatically be applied to all Woven Wood Shades for Cord Shrouds.

All prices are in U.S. dollars and do not include freight, duties or taxes for shipment to Alaska, Hawaii or Canada. GST and VAT are not included. Other restrictions and surcharges may apply. See freight policy for complete details.

Manufacturing specifications, options, surcharges and pricing are subject to change without notice.

Visit [www.mariak.com](http://www.mariak.com) for most recent downloads.



## West Lake Woven Wood Shades Additional Options for Standard, Waterfall & Twin Style Shades

Suggested Retail Price Table: Narrow Edge Bindings

Width		24	30	36	42	48	60	72	84	96
Length	36	12	15	18	21	24	30	36	42	48
	48	16	20	24	28	32	40	48	56	64
	54	18	22	27	31	36	45	54	63	72
	60	20	25	30	35	40	50	60	70	80
	66	22	27	33	38	44	55	66	77	88
	72	24	30	36	42	48	60	72	84	96
	78	26	32	39	45	52	65	78	91	104
	84	28	35	42	49	56	70	84	98	112
	90	30	37	45	52	60	75	90	105	119
	96	32	40	48	56	64	80	96	112	127
108	36	45	54	63	71	90	108	125	144	

Suggested Retail Price Table: Wide Edge Bindings

Width		24	30	36	42	48	60	72	84	96
Length	36	17	21	26	30	34	43	51	60	68
	48	23	28	34	40	46	57	68	80	91
	54	26	32	38	45	51	64	77	90	102
	60	28	36	43	50	57	71	85	100	114
	66	31	39	47	55	63	78	94	110	125
	72	34	43	51	60	68	85	102	119	137
	78	37	46	55	65	74	92	111	129	148
	84	40	50	60	70	80	100	119	139	159
	90	43	53	64	75	85	107	128	149	171
	96	46	57	68	80	91	114	137	159	182
108	52	64	77	90	102	128	154	179	205	

Suggested Retail Price Table: Privacy Liner

		Width								
		24	30	36	42	48	60	72	84	96
Length	36	28	35	42	49	56	70	84	98	112
	48	37	47	56	65	75	93	112	131	149
	54	42	53	63	74	84	105	126	147	168
	60	47	58	70	82	93	117	140	163	187
	66	51	64	77	90	103	128	154	180	205
	72	56	70	84	98	112	140	168	196	224
	78	61	76	91	106	121	152	182	212	243
	84	65	82	98	114	131	163	196	229	261
	90	70	88	105	123	140	175	210	245	280
	96	75	93	112	131	149	187	224	261	299
108	84	105	126	147	168	210	252	294	336	

All prices are in U.S. dollars and do not include freight, duties or taxes for shipment to Alaska, Hawaii or Canada. GST and VAT are not included. Other restrictions and surcharges may apply. See freight policy for complete details.

Manufacturing specifications, options, surcharges and pricing are subject to change without notice.

Visit [www.mariak.com](http://www.mariak.com) for most recent downloads.

### Suggested Retail Price Table: Black-Out Liner

Width	24	30	36	42	48	60	72	84	96
Length	36	45	54	63	72	90	108	126	144
48	48	60	72	84	96	120	144	168	192
54	54	68	81	95	108	135	162	189	216
60	60	75	90	105	120	150	180	210	240
66	66	83	99	116	132	165	198	231	264
72	72	90	108	126	144	180	216	252	288
78	78	98	117	137	156	195	234	273	312
84	84	105	126	147	168	210	252	294	336
90	90	113	135	158	180	225	270	315	360
96	96	120	144	168	192	240	288	336	384
108	108	135	162	189	216	270	324	378	432

### Suggested Retail Price Table: Optional Valance Liner (Privacy Beige Only)

Width	24	30	36	42	48	60	72	84	96
	5	6	6	7	7	9	10	11	12

### Suggested Retail Price Table: Valance Only - 6" Drop/Length

Width	24	36	48	60	72	84	96
Group A	Baja Sand, Driftwood Natural, Fiji Natural, Kyoto Brown, Kyoto Merlot, Laguna Umber, Latice Twilight, Mandalay Oak, Mandalay Pistachio, Medan Carmel, Monterey Oak, Panama Cedar, Penang Oak, Rustic Pecan, Tustic Tan, Tiki Carbon						
Retail Cost	38	52	63	82	93	105	118
Per Extra Inch Add:	6	8	10	13	15	17	19
Group B	Aspen Walnut, Bamboo Reeds Wheat, Bamboo Weave Camel, Bora Bora Natural, Camana Pecan, Cabana Saddle, Kowloon Bay, Nocturne Ebony, Sumatra Espresso, Sumatra Saddle, Sun Shade Brown, Sun Shade Natural, Westport Nutmeg						
Retail Cost	47	65	79	102	116	132	147
Per Extra Inch Add:	8	10	13	16	19	21	24
Group C	Akita Carbon, Akita Hazelnut, Akita Oak, Akita Walnut, Bamboo Forest Green, Bamboo Palm Carbon, Bamboo Palm Dark Oak, Bamboo Palm Espresso, Bamboo Palm Walnut, Forest Grass Sage, Hana Natural, Parchment Bleached, Prairie Brushwood, Sun Shade White, Tamarind Brown						
Retail Cost	51	70	85	109	124	141	157
Per Extra Inch Add:	8	11	14	18	20	23	25
Group D	Abaca Beige, Abaca Earth, Abaca Red Earth, Abaca Sage, Caribe Spice, Coronado White Sand, Harmony Natural, harmony Spice, Prairie Natural, Prairie Russet, Raffia Bark, Savanna Nighshade, St. martin Cappuccino, Terra Oak						
Retail Cost	62	85	103	134	152	172	192
Per Extra Inch Add:	10	14	17	21	24	28	31

#### Valance Only Liner Options: +30% Privacy Liner +40% Blackout Liner

**Valance Only:** Inside Mount a deduction of 3/8" will be made to the width  
 No deductions will be taken for Outside Mount  
 Outside Mount valance will be supplied with returns  
 Valance only orders come standard on a 1-1/2" headrail  
 Valances are 6" long standard and are stapled to the front of the headrail

Maximum valance width 96"  
 Maximum Length 24"

All prices are in U.S. dollars and do not include freight, duties or taxes for shipment to Alaska, Hawaii or Canada. GST and VAT are not included. Other restrictions and surcharges may apply. See freight policy for complete details.

Manufacturing specifications, options, surcharges and pricing are subject to change without notice.

Visit [www.mariak.com](http://www.mariak.com) for most recent downloads.

## West Lake Woven Wood Shades - Twin Shade with Privacy Liner

**Suggested Retail Price Table: Twin Shade with Privacy Liner - Group A Patterns**

	Width	24	30	36	42	48	60	72	84	96
Length	36	160	186	213	239	279	339	412	466	519
	48	173	200	226	266	306	372	440	519	559
	54	186	213	247	293	346	419	495	577	660
	60	200	229	275	321	379	452	550	641	733
	66	213	252	302	353	403	499	605	705	806
	72	226	275	330	385	440	550	660	769	879
	78	239	298	357	417	476	595	715	834	953
	84	259	321	385	449	513	632	769	898	1,026
	90	273	339	412	481	539	678	824	962	1,099
	96	293	359	439	513	559	705	879	1,037	1,197
	108	330	403	494	577	629	793	989	1,167	1,347
	Roll Ease Cord Loop Clutch System	90	105	120	130	135	140	150	160	170
	Wood Bottom Bar	13	16	18	20	22	27	31	36	40
	Baja Sand	Kyoto Brown			Lattice Twilight		Medan Camel		Penang Oak	
	Driftwood Natural	Kyoto Merlot			Mandalay Oak		Monterey Oak		Rustic Pecan	
	Fiji Natural	Laguna Umber			Mandalay Pistachio		Panama Cedar		Rustic Tan Tiki Carbon	

**Suggested Retail Price Table: Twin Shade with Privacy Liner - Group B Patterns**

	Width	24	30	36	42	48	60	72	84	96
Length	36	179	227	268	316	358	447	537	632	710
	48	197	245	286	340	382	471	561	668	752
	54	233	268	310	364	400	495	591	698	800
	60	257	286	334	382	436	519	621	734	841
	66	274	310	358	406	459	550	668	782	895
	72	292	328	382	430	483	600	728	847	960
	78	310	346	400	455	520	650	780	910	1,040
	84	328	364	424	490	560	700	847	980	1,120
	90	346	382	450	525	600	750	900	1,050	1,200
	96	364	406	480	560	640	800	960	1,120	1,280
	108	410	457	540	630	720	900	1,080	1,260	1,440
	Roll Ease Cord Loop Clutch System	90	105	120	130	135	140	150	160	170
	Wood Bottom Bar	13	16	18	20	22	27	31	36	40
	Aspen Walnut	*Bora Bora Natural			Kowloon Bay		Sumatra Saddle			
	Bamboo Reeds Wheat	Cabana Pecan			Noctune Ebony		Sun Shade Brown			
	Bamboo Weave Camel	Cabana Saddle			Sumatra Espresso		Sun Shade Natural			
		* Edge Binding Recommended					Westport Nutmeg			

### Woven Wood Surcharge Options

Two-On-One Headrail	\$20.00 Net (price as one overall shade)
Three-On-One Headrail	\$25.00 Net (price as one overall shade)
Cord Loop is available for both Front & Back	Add Cord Loop Surcharge Twice
Shades up to 92" in width shipped via FedEx:	\$ 4.00 per unit Net Freight Charge
Shades 92 1/8" to 125" in width shipped via FedEx:	\$ 75.00 per unit Net Freight Charge
Shades 125 1/8" or greater in width shipped via Common Carrier:	\$ 150.00 per shipment
<b>Surcharge of \$ 1.50 per shade will automatically be applied to all Woven Wood Shades for Cord Shrouds.</b>	
All prices are in U.S. Dollars and do not include freight, duties or taxes for shipments to Alaska, Hawaii or Canada. GST and VAT are not included. Other restrictions and surcharges may apply. See Freight Policy for complete details.	
Manufacturing specifications, options, surcharges and pricing are subject to change without notice.	

Visit [www.mariak.com](http://www.mariak.com) for most recent downloads.

## West Lake Woven Wood Shades - Twin Shade with Privacy Liner

**Suggested Retail Price Table: Twin Shade with Privacy Liner - Group C Patterns**

Length	Width	24	30	36	42	48	60	72	84	96
	36	219	265	302	347	389	539	662	810	920
48	232	275	312	351	400	542	687	829	935	
54	248	285	330	379	410	557	710	848	963	
60	278	307	357	400	458	590	729	871	1,020	
66	298	333	381	424	486	631	793	939	1,094	
72	318	352	405	448	510	707	877	1,039	1,200	
78	341	373	426	482	563	763	934	1,114	1,300	
84	362	394	452	530	610	817	1,012	1,199	1,402	
90	380	412	480	567	652	869	1,059	1,265	1,486	
96	400	439	514	604	707	917	1,132	1,345	1,570	
108	450	495	578	680	796	1,034	1,275	1,513	1,769	
	Roll Ease Cord Loop Clutch System	90	105	120	130	135	140	150	160	170
	Wood Bottom Bar	13	16	18	20	22	27	31	36	40

Akita Carbon	Bamboo Forest Green	Bamboo Palm Walnut	Prairie Brushwood
Akita Hazelnut	Bamboo Palm Carbon	Forest Grass Sage	Sun Shade White
Akita Oak	Bamboo Palm Dark Oak	Hana Natural	Tamarind Brown
Akita Walnut	Bamboo Palm Espresso	*Parchment Bleached	

\* Edge Binding Recommended

**Suggested Retail Price Table: Twin Shade with Privacy Liner - Group D Patterns**

Length	Width	24	30	36	42	48	60	72	84	96
	36	263	316	359	415	460	629	772	938	1,042
48	281	331	364	432	478	642	793	959	1,098	
54	298	348	406	459	490	667	830	989	1,148	
60	332	380	437	489	536	694	866	1,033	1,204	
66	356	404	469	513	565	786	964	1,125	1,314	
72	381	421	485	537	596	849	1,054	1,247	1,440	
78	403	444	508	632	659	914	1,123	1,337	1,559	
84	434	469	541	651	728	979	1,215	1,435	1,681	
90	455	494	575	677	780	1,050	1,316	1,575	1,842	
96	481	527	616	703	832	1,121	1,368	1,643	1,927	
108	539	592	693	793	937	1,262	1,539	1,849	2,170	
	Roll Ease Cord Loop Clutch System	90	105	120	130	135	140	150	160	170
	Wood Bottom Bar	13	16	18	20	22	27	31	36	40

*Abaca Beige	*Abaca Sage	Harmony Natural	Raffia Bark
*Abaca Earth	Caribe Spice	Harmony Spice	**St. Martin Cappuccino
*Abaca Red Earth	Coronado White Sand	Prairie Natural	Savanna Nightshade
		Prairie Russet	Terra Oak

\* Wide Edge Binding Recommended

\*\* Edge Binding Recommended

### Woven Wood Surcharge Options

Two-On-One Headrail	\$20.00 Net (price as one overall shade)
Three-On-One Headrail	\$25.00 Net (price as one overall shade)
Cord Loop is available for both Front & Back	Add Cord Loop Surcharge Twice
Shades up to 92" in width shipped via FedEx:	\$ 4.00 per unit Net Freight Charge
Shades 92 1/8" to 125" in width shipped via FedEx:	\$ 75.00 per unit Net Freight Charge
Shades 125 1/8" or greater in width shipped via Common Carrier:	\$ 150.00 per shipment
<b>Surcharge of \$ 1.50 per shade will automatically be applied to all Woven Wood Shades for Cord Shrouds.</b>	
All prices are in U.S. Dollars and do not include freight, duties or taxes for shipments to Alaska, Hawaii or Canada. GST and VAT are not included. Other restrictions and surcharges may apply. See Freight Policy for complete details.	
Manufacturing specifications, options, surcharges and pricing are subject to change without notice.	

Visit [www.mariak.com](http://www.mariak.com) for the most recent downloads.

## West Lake Woven Wood Shades - Twin Shade with Black-Out Liner

**Suggested Retail Price Table: Twin Shade with Black-Out Liner - Group A Patterns**

Width	24	30	36	42	48	60	72	84	96	
Length	36	172	201	230	259	302	366	445	503	560
	48	187	215	244	287	330	402	475	560	603
	54	201	230	267	316	373	452	534	623	712
	60	215	247	297	346	409	488	594	693	791
	66	230	272	326	381	435	539	653	762	871
	72	244	297	356	416	475	594	712	831	950
	78	259	322	386	450	514	643	772	900	1,029
	84	280	346	416	485	554	682	831	970	1,108
	90	294	366	445	519	582	733	890	1,039	1,187
	96	316	388	474	554	603	761	950	1,120	1,293
108	356	437	533	623	678	856	1,069	1,260	1,455	
Roll Ease Cord Loop Clutch System	90	105	120	130	135	140	150	160	170	
Wood Bottom Bar	13	16	18	20	22	27	31	36	40	

Baja Sand	Kyoto Brown	Lattice Twilight	Medan Camel	Penang Oak
Driftwood Natural	Kyoto Merlot	Mandalay Oak	Monterey Oak	Rustic Pecan
Fiji Natural	Laguna Umber	Mandalay Pistachio	Panama Cedar	Rustic Tan
				Tiki Carbon

**Suggested Retail Price Table: Twin Shade with Black-Out Liner - Group B Patterns**

Width	24	30	36	42	48	60	72	84	96	
Length	36	193	245	290	342	387	483	580	683	767
	48	213	264	309	367	412	509	606	722	812
	54	251	290	335	393	432	535	638	754	863
	60	277	309	361	412	470	561	670	793	909
	66	296	335	387	438	496	594	722	844	967
	72	316	354	412	464	522	648	786	915	1,036
	78	335	374	432	491	561	702	842	982	1,123
	84	354	393	458	529	605	756	915	1,058	1,209
	90	374	412	486	567	648	810	972	1,134	1,296
	96	393	438	518	605	691	864	1,036	1,209	1,382
108	442	493	583	680	777	972	1,166	1,360	1,555	
Roll Ease Cord Loop Clutch System	90	105	120	130	135	140	150	160	170	
Wood Bottom Bar	13	16	18	20	22	27	31	36	40	

Aspen Walnut	*Bora Bora Natural	Kowloon Bay	Sumatra Saddle
Bamboo Reeds Wheat	Cabana Pecan	Noctune Ebony	Sun Shade Brown
Bamboo Weave Camel	Cabana Saddle	Sumatra Espresso	Sun Shade Natural
	*Edge Binding Recommended		Westport Nutmeg

Woven Wood Surcharge Options	
Two-On-One Headrail	\$20.00 Net (price as one overall shade)
Three-On-One Headrail	\$25.00 Net (price as one overall shade)
Cord Loop is available for both Front & Back	Add Cord Loop Surcharge Twice
Shades up to 92" in width shipped via FedEx:	\$ 4.00 per unit Net Freight Charge
Shades 92 1/8" to 125" in width shipped via FedEx:	\$ 75.00 per unit Net Freight Charge
Shades 125 1/8" or greater in width shipped via Common Carrier:	\$ 150.00 per shipment
<b>Surcharge of \$ 1.50 per shade will automatically be applied to all Woven Wood Shades for Cord Shrouds.</b>	
All prices are in U.S. Dollars and do not include freight, duties or taxes for shipments to Alaska, Hawaii or Canada. GST and VAT are not included. Other restrictions and surcharges may apply. See Freight Policy for complete details.	
Manufacturing specifications, options, surcharges and pricing are subject to change without notice.	

Visit [www.mariak.com](http://www.mariak.com) for the most recent downloads.

## West Lake Woven Wood Shades - Twin Shade with Black-Out Liner

**Suggested Retail Price Table: Twin Shade with Black-Out Liner - Group C Patterns**

Width	24	30	36	42	48	60	72	84	96
36	237	286	306	347	419	568	705	849	994
48	251	298	326	379	429	585	720	874	1,006
54	268	308	356	410	442	602	767	916	1,040
60	300	332	385	432	495	637	787	940	1,102
66	322	360	411	458	525	682	856	1,014	1,182
72	344	381	437	483	550	763	948	1,122	1,296
78	368	403	460	521	608	824	1,009	1,203	1,404
84	391	425	489	572	658	883	1,093	1,295	1,514
90	410	445	519	612	704	938	1,143	1,366	1,605
96	432	474	555	652	764	990	1,223	1,453	1,696
108	485	533	624	734	859	1,117	1,376	1,633	1,910
Roll Ease Cord Loop Clutch System	90	105	120	130	135	140	150	160	170
Wood Bottom Bar	13	16	18	20	22	27	31	36	40

Akita Carbon	Akita Walnut	Bamboo Palm Dark Oak	Forest Grass Sage	Prairie Brushwood
Akita Hazelnut	Bamboo Forest Green	Bamboo Palm Espresso	Hana Natural	Sun Shade White
Akita Oak	Bamboo Palm Carbon	Bamboo Palm Walnut	*Parchment Bleached	Tamarind Brown

\*Edge Binding Recommended

**Suggested Retail Price Table: Twin Shade with Black-Out Liner - Group D Patterns**

Width	24	30	36	42	48	60	72	84	96
36	284	341	371	448	497	676	834	1,014	1,079
48	303	356	398	456	504	693	856	1,035	1,167
54	322	375	439	495	529	721	896	1,068	1,239
60	358	410	472	529	579	770	935	1,116	1,300
66	384	437	506	554	610	849	1,041	1,215	1,419
72	411	455	524	580	643	916	1,138	1,347	1,556
78	435	479	549	604	712	987	1,212	1,444	1,684
84	468	506	584	682	787	1,057	1,312	1,550	1,816
90	491	533	621	731	842	1,134	1,421	1,701	1,989
96	519	569	665	759	899	1,211	1,478	1,775	2,081
108	581	638	749	856	1,011	1,362	1,662	1,996	2,343
Roll Ease Cord Loop Clutch System	90	105	120	130	135	140	150	160	170
Wood Bottom Bar	13	16	18	20	22	27	31	36	40

*Abaca Beige	*Abaca Sage	Harmony Natural	Prairie Russet	Savanna Nightshade
*Abaca Earth	Caribe Spice	Harmony Spice	Raffia Bark	Terra Oak
*Abaca Red Earth	Coronado White Sand	Prairie Natural	**St. Martin Cappuccino	

\* Wide Edge Binding Recommended      \*\*Edge Binding Recommended

Woven Wood Surcharge Options	
Two-On-One Headrail	\$20.00 (price as one overall shade)
Three-On-One Headrail	\$25.00 (price as one overall shade)
Cord Loop is available for both Front & Back	Add Cord Loop Surcharge Twice
Shades up to 92" in width shipped via FedEx:	\$ 4.00 per unit Net Freight Charge
Shades 92 1/8" to 125" in width shipped via FedEx:	\$ 75.00 per unit Net Freight Charge
Shades 125 1/8" or greater in width shipped via Common Carrier:	\$ 150.00 per shipment
Surcharge of \$ 1.50 per shade will automatically be applied to all Woven Wood Shades for Cord Shrouds.	
All prices are in U.S. Dollars and do not include freight, duties or taxes for shipments to Alasta, Hawaii or Canada. GST and VAT are not included. Other restrictions and surcharges may apply. See Freight Policy for complete details.	
Manufacturing specifications, options, surcharges and pricing are subject to change without notice.	

Visit [www.mariak.com](http://www.mariak.com) for the most recent downloads.

## West Lake Woven Wood Shades Folding Door Shades

**Suggested Retail Price Table A**

	Width						
	48	60	72	84	96	120	Per Extra 12"
48	236	278	318	368	417	510	47
60	263	311	357	413	468	574	53
72	290	344	396	458	519	638	59
84	317	377	436	503	570	702	66
96	345	411	475	548	621	766	73
Valance 8"	71	73	93	95	117	146	10

Note: One-way folding door prices listed above.

Baja Sand	Kyoto Merlot	Monterey Oak	Rustic Tan
Driftwood Natural	Lattice Twilight	Panama Cedar	St. Martin Cappuccino
Fiji Natural	Mandalay Oak	Penang Oak	Tiki Carbon
Kyoto Brown	Mandalay Pistachio	Rustic Pecan	

**Suggested Retail Price Table B**

	Width						
	48	60	72	84	96	120	Per Extra 12"
48	251	297	341	394	447	547	50
60	282	335	385	446	505	621	58
72	313	372	430	497	564	694	65
84	344	410	475	549	623	767	72
96	375	448	520	601	681	841	80
Valance 8"	78	82	103	106	132	165	12

Note: One-way folding door prices listed above.

Aspen Walnut	Cabana Saddle	Nocturne Ebony
Bora Bora Natural	Kowloon Bay	Sun Shade Brown
Cabana Pecan		Sun Shade Natural

Folding Door Woven Wood Surcharge Options	
Split Draw (Center Opening)	\$99.00 Net
5% Fullness	5% is Standard (No Extra Charge)
20% Fullness	Add 20%
Privacy Liner	Add 30%
Black Out Liner	Add 40%
Handling Fees:	\$20.00 Net per shade up to 96"
	\$50.00 Net per shade over 96"
Shades up to 92" in width and/or length shipped via FedEx: \$ 4.00 per unit Net Freight Charge	
Shades 92 1/8" to 125" in width and/or length shipped via FedEx: \$ 75.00 per unit Net Freight Charge	
Shades 125 1/8" or greater in width and/or length shipped via Common Carrier: \$ 150.00 per shipment	
All prices are in U.S. Dollars and do not include freight, duties or taxes for shipments to Alasta, Hawaii or Canada. GST and VAT are not included. Other restrictions and surcharges may apply. See Freight Policy for complete details.	
Manufacturing specifications, options, surcharges and pricing are subject to change without notice.	

Visit [www.mariak.com](http://www.mariak.com) for the most recent downloads.



## West Lake Woven Wood Shades Folding Door Shades

**Suggested Retail Price Table C**

	Width						
	48	60	72	84	96	120	Per Extra 12"
48	277	329	379	439	498	612	55
60	314	375	434	502	570	701	65
72	351	421	488	565	641	791	75
84	389	467	543	628	713	880	83
96	426	513	597	691	784	970	93
Valance 8"	91	96	120	125	155	184	14

Note: One-way folding door prices listed above.

Akita Carbon	Akita Walnut	Bamboo Palm Dark Oak	Forest Grass Sage
Akita Hazelnut	Bamboo Forest Green	Bamboo Palm Espresso	Hana Natural
Akita Oak	Bamboo Palm Carbon	Bamboo Palm Walnut	Tamarind Brown

**Suggested Retail Price Table D**

	Width						
	48	60	72	84	96	120	Per Extra 12"
48	296	354	409	474	538	662	62
60	339	406	471	546	620	764	72
72	381	458	533	617	701	865	82
84	424	510	595	689	783	967	92
96	466	562	657	761	864	1,069	102
Valance 8"	101	108	133	140	174	218	16

Note: One-way folding door prices listed above.

Abaca Earth	St. Martin Cappucinno	Terra Oak
-------------	-----------------------	-----------

<b>Folding Door Woven Wood Surcharge Options</b>	
Split Draw (Center Opening)	\$99.00 Net
5% Fullness	5% is Standard (No Extra Charge)
20% Fullness	Add 20%
Privacy Liner	Add 30%
Black Out Liner	Add 40%
Handling Fees:	\$20.00 Net per shade up to 96"
	\$50.00 Net per shade over 96"
Shades up to 92" in width and/or length shipped via FedEx: \$ 4.00 per unit Net Freight Charge	
Shades 92 1/8" to 125" in width and/or length shipped via FedEx: \$ 75.00 per unit Net Freight Charge	
Shades 125 1/8" or greater in width and/or length shipped via Common Carrier: \$ 150.00 per shipment	
All prices are in U.S. Dollars and do not include freight, duties or taxes for shipments to Alasta, Hawaii or Canada. GST and VAT are not included. Other restrictions and surcharges may apply. See Freight Policy for complete details.	
Manufacturing specifications, options, surcharges and pricing are subject to change without notice.	

Visit [www.mariak.com](http://www.mariak.com) for the most recent downloads.



# Mariak

Many Window Solutions From One Source

575 West Manville Street, Rancho Dominguez, CA 90220  
 Customer Service Fax: (800) 459-6999 / International Fax: (310) 763-1749  
 PH: (800) 562-7425 / (310) 661-4400

## Purchase Order Woven Wood Shades

Account #: \_\_\_\_\_ Company Name: \_\_\_\_\_ Contact: \_\_\_\_\_ Purchase Order #: \_\_\_\_\_  
 Ship To Address: \_\_\_\_\_ Phone: \_\_\_\_\_ Sidemark: \_\_\_\_\_  
 City: \_\_\_\_\_ State: \_\_\_\_\_ Zip: \_\_\_\_\_ Fax: \_\_\_\_\_ Date Required: \_\_\_\_\_  
 EMAIL: \_\_\_\_\_

Ship Via (circle one): FedEX Common Carrier Mariak Truck Will Call

Line	Sidemark	Qty	Mount <sup>1</sup>	Width	Length	Shade Type <sup>2</sup>	Pattern <sup>3</sup>	Color <sup>4</sup>	Lift Type <sup>5</sup>	Lift Side <sup>6</sup>	Liner <sup>7</sup>	Edge Binding <sup>8</sup>	Hold Downs	Wood Bottom Bar <sup>9</sup>	Spacer Block
1															
2															
3															
4															
5															
6															
7															
8															
9															
10															

**Purchase Order Footnotes:**

<b>1. Mount:</b> (IM) - Inside Mount (OM) - Outside Mount	<b>3. Pattern:</b> Specify the fabric pattern name.	<b>7. Liner:</b> (None) (PL-FL4) - Privacy Liner FL4 Natural (PL-FL8) - Privacy Liner FL8 Beige (PL-FL5) - Privacy Liner FL5 Cocoa (PL-FL7) - Privacy Liner FL7 White (BO-FL9) - Black Out Liner FL9 Soft White (BO-FL2) - Black Out Liner FL2 Beige
<b>2. Shade Type:</b> (STND) - Standard Style Shade (WTF) - Waterfall Style Shade (TWN - STND) - Twin Fold with Standard Style Front Shade (TWN - WTF) - Twin Fold with Waterfall Style Front Shade (TDBU) - Top-Down / Bottom-Up Shade (ARCH) - Standard Style Shade with Arch Top Valance (ANGL) - Angled Top Style Shade (ZON1) - Two on One Headrail	<b>4. Color:</b> Specify the color number and name.	<b>Valance liners are available for an additional surcharge.</b>
	<b>5. Lift Type:</b> (PC) - Standard Pull Cord (Cord Lock Mechanism) (CCL) - Continuous Cord Loop (Clutch Mechanism) (MTR-BAT) - Motorized (Powered by Somfy Battery LT30 RTS) (MTR-DC-RTS) - Motorized (Powered by Low Voltage Somfy Sonese 30 RTS) (MTR-AC-RTS) - Motorized (Powered by High Voltage Somfy Sonese 50 RTS) (MTR-AC-HW) - Motorized (Powered by High Voltage standard 4-wire motor)	<b>8. Edge Binding:</b> If desired, specify edge binding color & Narrow or Wide.
	<b>6. Lift Cord Control:</b> (R) - Right Side Lift Cord (L) - Left Side Lift Cord	<b>9. Wood Bar:</b> If desired, specify the wood bottom bar color.

Note: For Twin Style Shades, please note if you want both Pull Cord for the Shade and Liner, Cord Loop for the Shade and Pull Cord for the Liner or Cord Loop for both the Shade and the Liner.  
 Note: All Twin Shades include Privacy or Black-Out Liner. Please specify one when ordering.



575 West Manville Street, Rancho Dominguez, CA 90220  
 Customer Service Fax: (800) 459-6999 / International Fax: (310) 763-1749  
 PH: (800) 562-7425 / (310) 661-4400

## Purchase Order Woven Wood Folding Door Shades

Account #: \_\_\_\_\_ Company Name: \_\_\_\_\_ Contact: \_\_\_\_\_ Purchase Order #: \_\_\_\_\_

Ship To Address: \_\_\_\_\_ Phone: \_\_\_\_\_ Sidemark: \_\_\_\_\_

City: \_\_\_\_\_ State: \_\_\_\_\_ Zip: \_\_\_\_\_ Fax: \_\_\_\_\_ Date Required: \_\_\_\_\_

EMAIL: \_\_\_\_\_ Ship Via (circle one):  FedEX  Common Carrier  Mariak Truck  Will Call

Line	Sidemark	Qty	Mount <sup>1</sup>	Width	Length	Shade Type	Pattern <sup>2</sup>	Color <sup>3</sup>	Stack Type <sup>5</sup>	Fullness <sup>6</sup>	Liner <sup>7</sup>	Valance <sup>8</sup>
1						Folding Door						
2						Folding Door						
3						Folding Door						
4						Folding Door						
5						Folding Door						
6						Folding Door						
7						Folding Door						
8						Folding Door						
9						Folding Door						
10						Folding Door						

**Purchase Order Footnotes:**

<b>1. Mount:</b>	(IM) - Inside Mount (OM) - Outside Mount
<b>3. Pattern:</b>	Specify the fabric pattern name.
<b>4. Color:</b>	Specify the color number and name.
<b>5. Stack:</b>	(L) - One Way Stack Left (R) - One Way Stack Right (S) - Split Stack
<b>6. Fullness:</b>	(5%) - Standard Fullness (20%) - Upgrade Fullness
<b>7. Liner:</b>	(None) Additional cost applies
	(PL-FL4) - Privacy Liner FL4 Natural (PL-FL8) - Privacy Liner FL8 Beige (PL-FL5) - Privacy Liner FL5 Cocoa
<b>8. Valance:</b>	Specify if valance is desired. Valances are not included in the standard price grids, but are available for a surcharge.

**Additional Notes:**

- A deduction of 1/4" will be made to the head rail length of all Inside Mount shades.
- For Inside Mount, a deduction of 3/4" will be made to the length of all shades.
- Valance face is 8" long; board mounted 5-1/2" deep and 3/4" thick. Attached to the front edge of the board with Velcro.
- If a valance is ordered, a deduction of 1 1/2" will be made to the length to allow for the valance board.
- Valance will include 5-1/2" inch returns.
- No deduction will be made to the length of Outside Mount shades.
- One Way Draw shades stack to the Left or Right when open.
- Split Draw shades open in the middle and have magnets in the center bars for complete closure. Additional surcharge applies.

**Additional Handling Fees Apply to all Folding Doors orders:**

- \$20.00 Net per shade up to 96"
- \$50.00 Net per shade over 96"



575 West Manville Street, Rancho Dominguez, CA 90220  
 Customer Service Fax: (800) 459-6999 / International Fax: (310) 763-1749  
 PH: (800) 562-7425 / (310) 661-4400

## Purchase Order Woven Wood Valance Only

Account #: \_\_\_\_\_ Company Name: \_\_\_\_\_ Contact: \_\_\_\_\_ Purchase Order #: \_\_\_\_\_

Ship To Address: \_\_\_\_\_ Phone: \_\_\_\_\_ Sidemark: \_\_\_\_\_

City: \_\_\_\_\_ State: \_\_\_\_\_ Zip: \_\_\_\_\_ Fax: \_\_\_\_\_ Date Required: \_\_\_\_\_

EMAIL: \_\_\_\_\_ Ship Via (circle one):  FedEX  Common Carrier  Mariak Truck  Will Call

Line	Sidemark	Qty	Mount <sup>1</sup>	Width	Length <sup>2</sup>	Shade Type	Pattern <sup>3</sup>	Color <sup>4</sup>	Liner <sup>5</sup>
1						Valance Only			
2						Valance Only			
3						Valance Only			
4						Valance Only			
5						Valance Only			
6						Valance Only			
7						Valance Only			
8						Valance Only			
9						Valance Only			
10						Valance Only			

**Purchase Order Footnotes:**

<b>1. Mount:</b>	(IM) - Inside Mount (OM) - Outside Mount
<b>2. Length:</b>	Standard Drop/Length is 6". Additinoal surcharge appies for each additional inch.
<b>3. Pattern:</b>	Specify the fabric pattern name.
<b>4. Color:</b>	Specify the color number and name.
<b>5. Liner:</b>	(None) (BO-FL9) - Black Out Liner FL9 Soft White (PL-FL4) - Privacy Liner FL4 Natural (BO-FL2) - Black Out Liner FL2 Beige (PL-FL8) - Privacy Liner FL8 Beige (PL-FL5) - Privacy Liner FL5 Cocoa (PL-FL7) - Privacy Liner FL7 White
<b>Note:</b>	+30% Privacy Liner +40% Black Out Liner

**Additional Notes:**

- For Inside Mount, a deduction of 3/8" will be made to the width
- No deductions will be taken for Outside Mount
- Valance only orders come standard on a 1-1/2" headrail
- Valance are 6" long standard and are stapled to the front of the headrail.
- Outside Mount valance will be supplied with returns.
- Maximum valance width 96"
- Maximum valance length 24"

# Mariak

Many Window Solutions From One Source

**BLANK PAGE**

575 West Manville Street  
Rancho Dominguez, CA 90220  
(800) 562-7425  
[www.mariak.com](http://www.mariak.com)